



DATREND
Systems Inc.

vPad-ESTM

**Electrical Safety Analyzer
for AAMI-ES1
IEC 60601**

Operating Manual

vPad-ESTM
Electrical Safety Analyzer
Operating Manual

© 2013-2014 Datrend Systems Inc.
Unit 130 - 4020 Viking Way
Richmond, BC • CANADA • V6V 2L4
Tel: 800.667.6557 (North America Only) or
604.291.7747 • Fax 604.294.2355
e-mail: customerservice@datrend.com



Revision	Revision History Description	Date
B	Update figures for PiPO tablet	2013-June-13
C	AC Fault, address	2013-Dec-12
D	Clarified Tablet RAM limits	2014-Aug-21

Copyright

Datrend Systems Inc. (“DSI”) agrees to a limited copyright release that allows you to reproduce manuals and other printed materials for use in service training programs and other technical publications. If you would like other reproductions or distributions, submit a written request to Datrend Systems Inc.

Unpacking and Inspection

Follow standard receiving practices upon receipt of the instrument. Check the shipping carton for damage. If damage is found, stop unpacking the instrument. Notify the freight carrier and ask for an agent to be present while the instrument is unpacked. There are no special unpacking instructions, but be careful not to damage the instrument when unpacking it. Inspect the instrument for physical damage such as bent or broken parts, dents, or scratches.

Claims

Our routine method of shipment is via common carrier. Upon delivery, if physical damage is found, retain all packing materials in their original condition and contact the carrier immediately to file a claim.

If the instrument is delivered in good physical condition but does not operate within specifications, or if there are any other problems not caused by shipping damage, please contact your local sales representative or DSI immediately.

Standard Terms and Conditions

Refunds & Credits

Please note only serialized products (products labelled with a distinct serial number) and accessories are eligible for partial refund and/or credit. Non-serialized parts and accessory items (cables, carrying cases, auxiliary modules, etc.) are not eligible for return or refund. In order to receive a partial refund/credit, the product must not have been damaged, and must be returned complete (meaning all manuals, cables, accessories, etc.) within 90 days of original purchase and in “as new” and resalable condition. The *Return Procedure* must be followed.

Return Procedure

Every product returned for refund/credit must be accompanied by a Return Material Authorization (RMA) number, obtained from Datrend Customer Service. All items being returned must be sent *prepaid* (freight, duty, brokerage, and taxes) to our factory location.

Restocking Charges

Products returned within 30 days of original purchase are subject to a minimum restocking fee of 15%. Products returned in excess of 30 days after purchase, but prior to 90 days, are subject to a minimum restocking fee of 20%. Additional charges for damage and/or missing parts and accessories will be applied to all returns. Products which are not in “as new” and resalable condition, are not eligible for credit return and will be returned to the customer at their expense.

Certification

This instrument was thoroughly tested and inspected and found to meet DSI’s manufacturing specifications when it was shipped from the factory. Calibration measurements are traceable to the National Research Council of Canada (NRC) and/or the National Institute of Standards and Technology (NIST). Devices for which there are no NRC/NIST calibration standards are measured against in-house performance standards using accepted test procedures.

Warranty

Warranty and Product Support

Datrend Systems Inc. ("DSI") warrants the Analyzer Base Unit of vPad-ES (the "Datrend product") to be free from defects in materials and workmanship under normal use and service for one (1) year from the date of original purchase. This warranty will be automatically extended to **two (2) years** from the date of original purchase, provided that calibration is performed on an **annual** basis by a Datrend Authorized Service Center*. During the warranty period DSI will, at our option, either repair or replace defects in materials and workmanship at no charge; provided the Datrend product is returned (shipping, duty, brokerage and taxes prepaid) to DSI. Any and all transportation charges incurred are the responsibility of the purchaser and are not included within this warranty. This warranty extends only to the original purchaser and does not cover damage from abuse, neglect, accident or misuse or as the result of service or modification by other than DSI. IN NO EVENT SHALL DATREND SYSTEMS INC. BE LIABLE FOR CONSEQUENTIAL DAMAGES.

This warranty is subject to the following limitations:

- Tablet PC: per tablet manufacturer's original warranty
- Standard Accessories: 90 day limited warranty
- Damage due to activation of devices under test which are connected to the "applied parts" inputs is not covered under the warranty
- Re-calibration of the instrument, which has a recommended annual calibration frequency, is not covered under the warranty.

No warranty shall apply when damage is caused by any of the following:

- Power failure, surges, or spikes,
- Damage in transit or when moving the instrument,
- Improper power supply such as low voltage, incorrect voltage, defective wiring or inadequate fuses,
- Accident, alteration, abuse or misuse of the instrument,
- Fire, water damage, theft, war, riot, hostility, acts of God, such as hurricanes, floods, etc.

Only serialized products (those items bearing a distinct serial number tag) and their accessory items are covered under this warranty. PHYSICAL DAMAGE CAUSED BY MISUSE OR PHYSICAL ABUSE IS NOT COVERED UNDER THE WARRANTY. Items such as cables and non-serialized modules are not covered under this warranty.

This warranty gives you specific legal rights and you may have other rights, which vary from province to province, state to state, or country to country. This warranty is limited to repairing the instrument to DSI's specifications.

When you return an instrument to DSI for service, repair or calibration, we recommend shipment using the original shipping foam and container. If the original packing materials are not available, we recommend the following guide for repackaging:

- Use a double-walled carton of sufficient strength for the weight being shipped.
- Use heavy paper or cardboard to protect all instrument surfaces. Use non-abrasive material around all projecting parts.
- Use at least four inches of tightly packed, industrial-approved, shock-absorbent material all around the instrument.

DSI will not be responsible for lost shipments or instruments received in damaged condition due to improper packaging or handling. All warranty claim shipments must be made on a prepaid basis (freight, duty, brokerage, and taxes). No returns will be accepted without a Return Materials Authorization ("RMA") number. Please contact Datrend (refer to Chapter 5 of this manual) to obtain an RMA number and receive help with shipping/customs documentation.

* Subject to some exclusions, based on sales territory. Contact Datrend for details.

Warranty Disclaimer

Should you elect to have your instrument serviced and/or calibrated by someone other than Datrend Systems or an Authorized Service Centre, please be advised that the original warranty covering your product becomes void when the tamper-resistant Quality Seal is removed or broken without proper factory authorization. We strongly recommend, therefore, that you send your instrument to Datrend Systems or an Authorized Service Centre for service and calibration, especially during the original warranty period.

In all cases, breaking the tamper-resistant Quality Seal should be avoided at all cost, as this seal is the key to your original instrument warranty. In the event that the seal must be broken to gain internal access to the instrument (e.g., in the case of a customer-installed firmware upgrade), you must first contact Datrend Systems at 1-604-291-7747. You will be required to provide us with the serial number for your instrument as well as a valid reason for breaking the Quality Seal. You should break this seal only after you have received factory authorization. Do not break the Quality Seal before you have contacted us! Following these steps will help ensure that you will retain the original warranty on your instrument without interruption.

WARNING

Unauthorized user modifications or application beyond the published specifications may result in electrical shock hazards or improper operation. Datrend Systems will not be responsible for any injuries sustained due to unauthorized equipment modifications.

DSI DISCLAIMS ALL OTHER WARRANTIES, EXPRESSED OR IMPLIED, INCLUDING ANY WARRANTY OF MERCHANTABILITY OR FITNESS FOR A PARTICULAR PURPOSE OR APPLICATION.

**THIS PRODUCT CONTAINS NO USER-SERVICEABLE COMPONENTS.
UNAUTHORIZED REMOVAL OF THE INSTRUMENT COVER SHALL VOID
THIS AND ALL OTHER EXPRESSED OR IMPLIED WARRANTIES.**

Note: Calibration of Datrend products typically involves adjustment of parameters stored in firmware by proprietary software. Parties other than Datrend and its Authorized Service Centers are limited to verification of the status of the accuracy of the instrument. Do not confuse verification with calibration.

vPad™, vPad-XPORT™, vPad-ES™, vPad-353™, vPad-AS™, vPad-A3™, vPad-Record Manager™, vPad-RM™, vPad-EQM™, vPad-Check™, vPad-Cal™, and Datrend Docs™ and CMX™ are trademarks of Datrend Systems Inc.

Android™ is trademark of Google Inc.

Table of Contents

ABBREVIATIONS AND DEFINITIONS	VII
SYMBOL DEFINITIONS	IX
1 SPECIFICATIONS	1
1.1 Electrical Safety Testing Standards	1
1.2 Safety Tests	1
1.3 Instrument Specifications	2
1.3.1 Voltage Measurement	2
1.3.2 Load Current Measurement	2
1.3.3 Power Measurement	2
1.3.4 Resistance Measurement	2
1.3.5 Leakage Current Measurement	3
1.3.6 ECG Simulator	3
1.4 Measurement Terminals	4
1.4.1 Test Receptacle	4
1.4.2 Current Source Terminals (SRC+/-)	4
1.4.3 Meter Input Terminals (EXT+/-)	4
1.4.4 ECG Terminals (APx)	4
1.5 User Interface	5
1.6 Electrical Ratings	6
1.7 Externally-Accessible Fuses	6
1.8 Environment for Use	6
1.9 Dimensions	6
1.10 Weight	6
1.11 Standard Accessories	7
1.12 Optional Accessories	7
1.13 Compliance With Standards	7
2 OVERVIEW	9
2.1 Features	9
2.1.1 Analyzer Base Unit	9
2.1.2 Test Receptacle Configuration	11
2.1.3 User Interface	12
2.2 Test Modes	13
2.3 Safety Test Standards	15
3 SETUP	21
4 OPERATION	27
4.1 HOME Screen	27
4.2 Startup	29

vPad-ES OPERATORS MANUAL

- 4.3 Test Navigation 31
- 4.4 Receptacle Control 31
- 4.5 Voltage Tests 33
 - 4.5.1 Line Voltage 34
 - 4.5.2 External Voltage 35
 - 4.5.3 External Micropotential 36
- 4.6 Equipment Load Tests 38
 - 4.6.1 Load Current 39
 - 4.6.2 Power Consumption 39
- 4.7 Resistance Tests 40
 - 4.7.1 Line Cord Resistance 41
 - 4.7.2 External Resistance 42
 - 4.7.3 Measurement Method 43
 - 4.7.4 Test Application 43
- 4.8 Leakage Tests 44
 - 4.8.1 Chassis Leakage 46
 - 4.8.2 Ground Leakage 47
 - 4.8.3 External Leakage 48
 - 4.8.4 Test Application 50
- 4.9 Patient Lead Tests 51
 - 4.9.1 Lead-to-Ground Leakage 52
 - 4.9.2 Lead-to-Lead Leakage 53
 - 4.9.3 Lead Isolation Test 55
 - 4.9.4 Test Application 57
- 4.10 Leakage Settings 59
- 4.11 ECG Simulator 63
 - 4.11.1 ECG Test 65
 - 4.11.2 Common-Mode Test 66
- 4.12 Equipment Inspection 67
 - 4.12.1 Inspection Tasks 67
 - 4.12.2 Performing an Inspection 70
- 4.13 Data Recording 72
 - 4.13.1 Using the Android Keyboard 72
 - 4.13.2 Recording Measurements and Notes 74
 - 4.13.3 Viewing Measurements and Notes 76
 - 4.13.4 Recording Equipment Information 77
 - 4.13.5 Creating a Test Record 79
- 4.14 Record Manager App 83

- 5 CALIBRATION AND MAINTENANCE 85

- APPENDIX A. SAMPLE TEST RECORD 87

Abbreviations and Definitions

The following abbreviations, terms and acronyms are used throughout this manual:

μA	Micro-ampere
A	Ampere
AAMI	American Association of Medical Instrumentation
AP	Applied Parts (patient leads)
App	Software application for a mobile device
Cct.	Abbreviation for circuit (ie. electrical circuit in a power distribution system)
Earth	See GND
EUT	Equipment Under Test. The electrical device being tested.
GND or Ground	The line (conductor) connected to a place that is maintained at "Ground" or "Earth" voltage. Same as Protective Earth.
Hz	Hertz
IEC	International Electrotechnical Commission
IME	Android input method (e.g. keyboard)
kHz	kilohertz
L1 or Line 1	Line 1 of the AC supply voltage, or "mains". In North America, the "Hot" or "Live" line (conductor) of the AC supply.
L2 or Line 2	Line 2 of the AC supply voltage, or "mains". In North America, the "Neutral" line (conductor) of the AC supply.
LA	left arm ECG lead
LL	left leg ECG lead
MAINS	The voltage provided by the building installation, nominally 120 VAC or 230 VAC depending on the country
M.A.P. / MAP	Mains on applied part(s)
Measurement Category I Terminal	Intended for measurements on circuits with no direct connection to MAINS (CAT I)
Measurement Category II Terminal	Intended for measurements on circuits which may have a direct connection to MAINS (CAT II)
MHz	Megahertz
NC	Normal Condition of AC supply to EUT: ground and neutral are both connected

vPad-ES OPERATORS MANUAL

PE	Protective Earth. The line (conductor) connected to a place that is maintained at "Ground" or "Earth" voltage.
RA	right arm ECG lead
RL	right leg ECG lead
RMS	Root-Mean-Square measurement of a parameter (eg. V_{rms} , A_{rms})
Safety Standard	Standards established by various national and international agencies. The most recognized Standards Organizations include: AAMI - Association for Advancement of Medical Instrumentation IEC - International Electrotechnical Commission
SFC	Single-fault condition of AC supply to EUT: either ground or neutral is disconnected, but not both
Type B (Body)	IEC protection class referring to patient-applied parts (leads) which are not isolated from ground
Type BF (Body Floating)	IEC protection class referring to patient-applied parts (leads) which are isolated from ground
Type CF (Cardiac Floating)	IEC protection class referring to patient-applied parts (leads) which are isolated from ground and also intended for direct cardiac application
V	Volt
V1-V6	Precordial (chest) ECG leads
Vrms	Volts rms

Symbol Definitions

The following symbols may be found on vPad-ES:



CONSULT MANUAL FOR PROPER OPERATION

The operating manual provides valuable information on the proper use of vPad-ES. It is highly recommended the operator read the instructions thoroughly before operating the device. It is possible to damage the Equipment Under Test (EUT) and/or cause harm to the operator if vPad-ES is used incorrectly.



MAXIMUM RATED INPUT CURRENT:

20AMPS @ 100 - 120 VAC, 60 Hz when used with power cord 3000-010
15AMPS @ 100 - 120 VAC, 60 Hz when used with power cord 3000-009

The maximum rated input current is dependent on the power cord used. When using standard 15A electrical circuits, use the 3000-009 power cord. If current between 15 and 20A is required, find an appropriate power receptacle rated to 20A and use power cord 3000-010.



Patient Leads: Hazardous Voltage: 264 VAC or 500 VDC max

This warning appears on the label for the patient lead connections, located at the rear of vPad-ES. During testing of the isolation of the EUT patient applied parts leads with respect to either ground, or to the power input leads, a voltage of either 100% of the AC line voltage may be present on the (CAT I) lead connectors. This voltage may reach a maximum of ~264 VAC and, while current limited, represents a serious shock hazard to the operator. Proper precautions should be taken when performing a test which includes the application of this voltage to the EUT patient leads. The display of vPad-ES will indicate when a hazardous voltage is present at the patient lead connectors.



CAUTION: Electrical Shock Hazard, Refer Servicing to Qualified Personnel
CAUTION: Consult Accompanying Documents

These warnings appear on the serial number label of vPad-ES. vPad-ES contains hazardous electrical voltages internally which WILL BE present when the covers are removed. The operator should read the Operating Manual to determine what actions to take in the event of failure of vPad-ES. Refer to the Troubleshooting and Maintenance Section of the Operating Manual.



Kelvin Cable

The Kelvin Cable (CAT I) is used to measure the Line Cord Grounding Resistance, using a pulsed 1 amp current (200 mA RMS). The voltage present at these terminals is below 6 volts. Consult the Operating Manual for the proper operation of the Grounding Resistance test.

vPad-ES OPERATORS MANUAL



DO NOT EXCEED THE FOLLOWING CURRENT LOAD ON THE EUT RECEPTACLE:

15AMPS @ 100 - 120 VAC, 60 Hz (in 20A circuit)
11AMPS @ 100 - 120 VAC, 60 Hz (in 15A circuit)
12AMPS @ 230 VAC, 50 Hz (in 16A circuit)

The regulatory requirements for loading a circuit (cct.) in a power distribution system sets a current limit on any individual receptacle to 80% of the value of the circuit breaker on that circuit. For instance, in a circuit with a 15A circuit breaker (or fuse), the maximum current allowed to be drawn from any individual receptacle is 12A. Allowing 1A for the vPad-ES circuitry, the load current for the Equipment Under Test (EUT) should not exceed 11A. These limits are set by the Electrical Code in most jurisdictions in an attempt to avoid unexpected circuit overloads and subsequent circuit failure. If the EUT load is expected to approach the maximum value on a routine basis, it is recommended that a circuit with only a single receptacle be provided for use with vPad-ES.



WARNING: OPENING THE vPad-ES MAY COMPROMISE USER SAFETY. REFER SERVICING TO DATREND AUTHORIZED AGENT.

vPad-ES is a complex instrument which contains internally distributed line voltages and other high voltages for specific measurement purposes. Failure to observe appropriate measures when the instrument has been opened, or failure to reassemble correctly may compromise the safety of the user.



WARNING: GROUNDING CIRCUIT CONTINUITY IS VITAL FOR SAFE OPERATION. NEVER OPERATE THE vPad-ES WITH GROUNDING CONDUCTOR DISCONNECTED.

Proper grounding is essential to ensure operator safety. Do not bypass the grounding provisions inherent in the design of vPad-ES, otherwise, the operator may be subjected to an electrical shock risk.



WARNING: HAZARDOUS VOLTAGES OR CONDITIONS MAY EXIST DURING TESTS. CONSULT THE ACCOMPANYING DOCUMENTS FOR APPROPRIATE PRECAUTIONS.

During the execution of an electrical safety test on the EUT, vPad-ES may apply a high voltage (up to 264 VAC) to the EUT. While this voltage is current limited, it does represent a shock hazard to the operator if precautions are not followed. Consult the instructions in this manual regarding Isolation Leakage Current tests (MAP test) for further information.

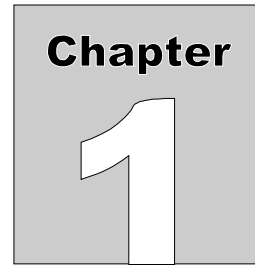

1 Specifications

Equipment Performance Specifications

1.1 Electrical Safety Testing Standards

- IEC60601-1
- ANSI/AAMI-ES1

1.2 Safety Tests

- Line Voltage
- External (point-to-point) Voltage
- External (point-to-point) Micropotential
- Equipment Load Current
- Equipment Power Consumption
- Line Cord Resistance
- External (point-to-point) Resistance
- Chassis Leakage Current (IEC touch current)
- Ground Leakage Current (IEC earth leakage current)
- External (point-to-point) Leakage Current
- Patient Lead Leakage to Ground (earth)
- Patient Lead-to-Lead Leakage (IEC auxiliary leakage)
- Patient Lead Isolation Test (IEC MAP test)

1.3 Instrument Specifications

1.3.1 Voltage Measurement

Line voltage	
Range.....	90 to 264 V rms
Accuracy	$\pm(2\% \text{ of reading} + 0.2 \text{ V})$
External (point-to-point) voltage	
Range.....	0 to 300 V rms
Accuracy	$\pm(1\% \text{ FS} + 0.2 \text{ V})$
External (point-to-point) micropotential	
Ranges.....	0 to 199.9 mV rms 200 to 1,999 mV rms 2000 to 19,999 mV rms
Accuracy	$\pm(1\% \text{ of reading} + 1 \text{ mV})$

1.3.2 Load Current Measurement

Ranges	0 to 1.999 A ac rms 2.00 to 19.99 A ac rms
Accuracy	$\pm(2\% \text{ reading} + 0.2\text{A})$
Duty cycle	0 A to 10 A, continuous 10 A to 15 A, 7 min. on/3 min. off 15A to 20 A, 5 min. on/5 min. off

1.3.3 Power Measurement

Range	0 to 2400 watts
Accuracy	$\pm(5\% \text{ reading} + 5\text{W})$

1.3.4 Resistance Measurement

Modes	Four-terminal, fully isolated
Test Current	1A pulsed, 0.2A rms
Range	0.000 to 2.000
Accuracy	$\pm(1\% \text{ of reading} + 0.02)$

1.3.5 Leakage Current Measurement

Modes.....	AC+DC (True-rms) AC only DC only
Patient Load Selection.....	AAMI ES1-1993 IEC 60601
Crest factor	<=3
Ranges.....	0.0 to 199.9 μ A 200 to 1,999 μ A 2,000 to 19,999 μ A
Accuracy	
DC to 1 kHz.....	\pm (1 % of reading + 1 μ A)
1 to 100 kHz	\pm (2 % of reading + 1 μ A)
100 kHz to 1 MHz.....	\pm (5 % of reading + 1 μ A)
Isolation test voltage.....	100 % \pm 5 % of AC supply

1.3.6 ECG Simulator

Output	
Amplitude.....	1 mV QRS into Lead II
Impedance.....	500 ohms
Accuracy	
Frequency.....	\pm 1 %
Amplitude.....	\pm 2 %
Waveforms	
ECG Complex.....	30, 60, 120, 180, 240 and 300 BPM
Square wave.....	0.125 Hz, 2 Hz and 1 kHz
Pulse wave.....	63 msec, 30PPM and 60PPM
Triangle wave.....	2 Hz
Sine wave.....	0.5, 10, 40, 50, 60 and 100 Hz
CMRR tests.....	SQR 2Hz & 1 kHz, PUL 4 sec, SIN 0.5, 50 & 60Hz
Arrythmias.....	VFIB, AFIB, SVT, VTACH, PVC and ASYS

1.4 Measurement Terminals

1.4.1 Test Receptacle

Category.....	CAT II
Maximum Voltage	
North America.....	132 VAC
Europe/Asia.....	264 VAC
Maximum Current	
North America.....	20A AC
Europe/Asia.....	13A AC

Use vPad power cord 3000-009 for instruments rated to 15A
Use vPad power cord 3000-010 for instruments rated to 20A

1.4.2 Current Source Terminals (SRC+/-)

Category.....	CAT I
Maximum Voltage.....	6V
Maximum Current.....	200 mA RMS

1.4.3 Meter Input Terminals (EXT+/-)

Category.....	CAT I
Maximum Voltage	
External μ A/mV mode.....	20V
External voltage mode.....	300V
Maximum Current.....	0.2 mA @ 300V

1.4.4 ECG Terminals (APx)

Category.....	CAT I
Maximum Voltage.....	264 VAC (Isolation Test)
Maximum Current.....	14mA AC @ 264 VAC



Connect measurement terminals **ONLY** as instructed in this manual.
See Chapter 4, Operation

1.5 User Interface

Display.....	10.1" colour LCD (1280 x 800)
User Controls.....	Capacitive touchscreen
Wired Connectivity.....	Micro USB 2.0 Type B (shareable with base unit) USB 2.0 Type A (premium tablet only) XBUS Interface (RJ11-6)
Wireless Connectivity.....	802.11 b/g/n Bluetooth 2.1+ EDR
Memory, Internal.....	16GB Maximum †
Memory, Expansion.....	16GB to 32GB Micro SD Card (optional)
Modes of Operation.....	Manual (standard) Automatic (accessory option)

†16 GB is the maximum amount of internal memory installed in the tablet. The internal memory is formatted similar to a hard disk to facilitate storage and access to data including the Operating System, Programs, and Data. The formatting process reduces that amount of storage available for use by the tablet. Additionally, the Operating System can consume up to 4 GB of storage. The nominal internal storage available for users is approximately 12 GB as shipped from Datrend.

If additional storage is required, an SD card can be installed in the tablet. Upon initial installation of an SD card, check for proper operation and that the correct size is reported. It may be necessary to format your SD card. If so, ensure that the card is formatted for the FAT32 file system, and that the long format mode is used (do NOT use “quick format”).

Equipment Technical Specifications

1.6 Electrical Ratings

Country Specific: 120 VAC \pm 10%, 60 Hz, 16A in 20A circuit
 120 VAC \pm 10%, 60 Hz, 12A in 15A circuit
 230 VAC \pm 10%, 50 Hz, 13A

Notes:

- This instrument has been designed to test equipment that meets local power distribution standards, which limit devices to draw no more than 80% of the specified current capacity of a circuit. For instance, a single device should draw no more than 16A from a single receptacle on a 20A circuit.
- Transient overvoltages typically present on the mains supply are expected to be impulse withstand (overvoltage) category II of IEC 60364-4-443

1.7 Externally-Accessible Fuses

20A / 250V AGC

1.8 Environment for Use

15 to 40 °C
10% to 90% RH
Altitude: 2000m max.
Indoor use only
Pollution Degree 2

1.9 Dimensions

Base unit.....	11.8 x 8.9 x 3.3 in. (30 x 23 x 8.4 cm)
Tablet PC (detachable).....	10.5 x 6.7 x 0.5 in. (27 x 17 x 1.3 cm)

1.10 Weight

4.4 lb (2.0kg)

1.11 Standard Accessories

vPad Kelvin Cable.....	P/N 3140-475
vPad Tablet USB Cable.....	P/N 3140-478
vPad Tablet DC Cable.....	P/N 3140-476 (12V) or -477 (5V), depending on tablet model
Power Cord (country specific)	
North America 15A.....	P/N 3000-009
North America 20A.....	P/N 3000-010
Continental Europe.....	P/N 3000-011
United Kingdom.....	P/N 3000-012
Australia.....	P/N 3000-018

1.12 Optional Accessories

For a complete list of available accessories, visit www.datrend.com or contact Datrend Customer Service (see Chapter 5 for contact details)

1.13 Compliance With Standards

vPad-ES has been certified to meet the following safety standards:

CAN/CSA-C22.2 No. 61010-1-(2nd Edition) - Safety Requirements for Electrical Equipment for Measurement, Control, and Laboratory Use, Part 1: General Requirements

UL Std. No. 61010-1 (2nd Edition) - Safety Requirements for Electrical Equipment for Measurement, Control, and Laboratory Use - Part 1: General Requirements

Following manufacture, all units are subjected to, and have passed the requirements of the 'Routine Tests' defined in Annex F of the above Standard(s).

vPad-ES OPERATORS MANUAL

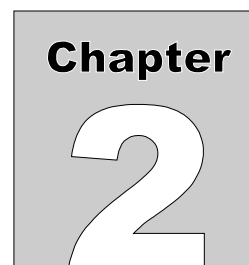

2 Overview

vPad-ESTM is a manually-operated electrical safety analyzer providing basic electrical safety testing of medical devices with patient leads. This chapter provides an overview of vPad-ES features and test modes. A summary of testing requirements specified by NFPA®, AAMI and IEC safety standards is included at the end of this chapter.

2.1 Features

2.1.1 Analyzer Base Unit

The vPad-ES safety analyzer is comprised of an Android™-powered tablet which provides the user interface, and a Base Unit which provides the analyzer instrumentation. Referring to *Figure 1*, controls, interfaces and features of the Analyzer Base Unit are:

Item	Description/Function
1. AC supply input	Connect to AC power supply using line cord provided with vPad-ES
2. Line fuse	Main supply fuse; replace with AGC 20A / 250V
3. AUX test jack	Use when testing applied part leakage current of Class II medical equipment
4. Test receptacle	Connect to AC power input of Equipment Under Test (EUT)
5. Receptacle Active indicator	Lights when power is applied to test receptacle (4)
6. Tablet tray	Supports tablet when safety analyzer in use
7. TABLET DC	Connect to DC power input of tablet, using cable provided (either 12V (P/N 3140-476) or 5V (P/N 3140-477), according to tablet model)
8. TABLET USB	Connect to USB port of tablet, using cable provided (P/N 3140-478)
9. Cable storage bay	Store tablet USB and Power cables here when transporting or storing vPad-ES

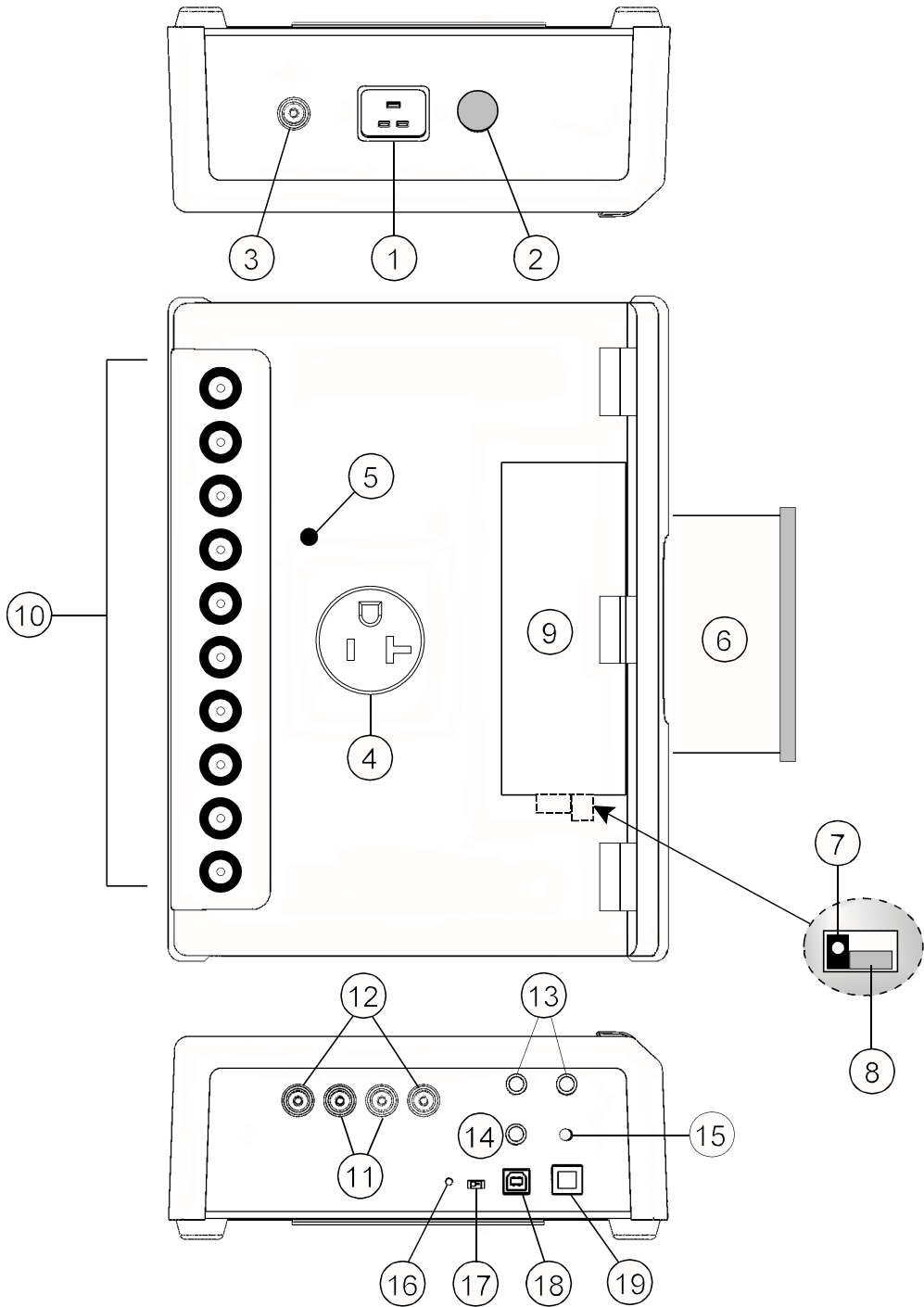

Figure 1 - vPad-ES Analyzer Base Unit.

vPad-ES OPERATORS MANUAL

Item	Description/Function
10. Binding posts	Connect to EUT patient leads or applied parts, for example, ECG leads
11. Meter input, EXT+/-	Input to voltmeter or leakage measuring device
12. Current source, SRC+/-	Current source output for four-wire resistance measurement
13. Test resistor, 1.0 Ω	Use to verify function of ohmmeter
14. Test current, 100 μ A	Use to verify function of leakage measuring device
15. AC supply indicator	Lights when AC supply is connected to Base Unit
16. Reset button	Press to reset Base Unit
17. Normal/remote switch	Set to "normal" for operation by Android tablet; set to "remote" for operation via remote control from PC running Microsoft Windows® (Android tablet is bypassed)
18. PC IN	USB Type B (Device) - connect to PC for remote control operation
19. XBUS Port	Connect to Vision-Pad Technology™ accessory devices

2.1.2 Test Receptacle Configuration

vPad-ES may be equipped with one of these test receptacles, but other receptacles may be substituted to satisfy customer requirements. For additional configurations, please contact Datrend Customer Service.

North America



Western Europe



United Kingdom



Australia/China

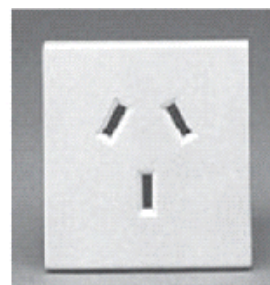

vPad-ES OPERATORS MANUAL

2.1.3 User Interface

The user interface of vPad-ES is based on an Android™-powered tablet computer. Android provides numerous features which make vPad-ES unique as a biomedical test instrument:

- HD colour display with capacitive touchscreen
- 4 to 16GB of internal memory (depending on tablet model), expandable via accessory SD Card
- WiFi for wireless connectivity to printers, PC's, and the Internet
- Bluetooth for wireless connectivity to PC's and hardware add-ons (keyboard; barcode scanner; etc.)
- USB Host Port on premium Vision-Pad tablets supports hardware accessories such as flash drive, keyboard, barcode scanner, etc.
- Still-image camera and audio/video recorder
- Full-size (8½ x 11") document printing
- Pre-installed software applications ("apps"): file manager; Internet browser; PDF and e-book reader; e-mail; calendar; notepad; plus many others
- More Android apps easily installable via direct download from Google Play, GetJar, and other sources

The vPad-ES app for Android drives the Analyzer Base Unit. In addition to large, easy-to-read indicators and pushbutton controls necessary for analyzer operation, Datrend's vPad apps provide data recording and other features which are unprecedented in a safety analyzer in this price range:

- Save tens of thousands of Test Records on the safety analyzer, with each Record storing a practically unlimited number of measurement values in combination with in-line notations
- Save equipment information to Test Records, including control number, description, make, model, serial number and more
- Perform and record equipment inspections following the *General Devices Acceptance Procedure* published by the ECRI Institute (USA)
- Manage vPad Test Records: copy; delete; convert to PDF; and print to full-size (8½ x 11") pages - on an individual basis or on multiple selected Records at once

More information on the many features of the user interface and apps may be found in Chapter 4 of this manual.

2.2 Test Modes

vPad-ES provides a variety of test modes which are useful for performing electrical safety measurements on medical equipment.

<i>Line Voltage</i>	Use this mode to test the AC supply which powers vPad-ES. Measure voltages from AC supply hot to neutral; from hot to ground; and from neutral to ground.
<i>External Voltage</i>	Use this mode to check larger voltages between two arbitrary points, up to 300V RMS maximum.
<i>External Micropotential</i>	Use this mode to observe small voltages in the millivolt range between two arbitrary points. In this mode, the voltmeter has a low input resistance (1 kohm). vPad-ES auto-ranges to suit the potential being measured (200, 2000 or 20000 mV RMS full scale).
<i>Load Current</i>	Use this mode to measure current drawn from the AC supply by the equipment under test (EUT). vPad-ES auto-ranges to suit the current being measured (2A or 20A AC full scale).
<i>Power</i>	Use this mode to measure the power consumption of the EUT. Power is calculated from the product of the line voltage and load current. This test mode is useful for monitoring power consumption of loads over 50W.
<i>Line Cord Resistance</i>	Use this mode to test the resistance of the EUT's power supply cord, up to a maximum of 2 Ω . In this test mode, vPad-ES uses an isolated, four-wire ohmmeter with a pulsed 1 amp current source.
<i>External Resistance</i>	Use this mode to measure resistance between two arbitrary points, up to 2 Ω . A four-wire ohmmeter is used.

vPad-ES OPERATORS MANUAL

- Chassis Leakage*** Use this mode to check for leakage current that may flow from the chassis or enclosure of the EUT to ground of the AC supply.
- For Chassis and other leakage tests described below, you may choose either the AAMI or IEC measuring device (MD). In addition to true-RMS readings, the MD can be set for AC-only or DC-only measurements. The test receptacle may be set to normal/reverse polarity, normal/open neutral, and normal/open ground. As required, vPad-ES auto-ranges to suit the leakage being measured (200, 2000 or 20000 μ A full scale).
- Ground Leakage*** Use this mode to measure leakage current which flows through the ground wire of the EUT's power cord.
- External Leakage*** In this mode, the MD can be used to measure leakage currents which may flow between two arbitrary points.
- Lead Leakage to Ground*** Use this mode to check for leakage current from patient leads of the EUT to ground of the AC supply. Leads may be tested individually or in various combinations.
- Lead-to-Lead Leakage*** Use this mode to check for leakage current from a selected patient lead of the EUT to all other patient leads shorted together.
- Lead Isolation Test*** Use this mode to check for leakage current that may be caused by driving one or more EUT leads with an isolated, current-limited test voltage equal to the AC supply. In this mode, you may test patient leads individually or in various combinations.
- ECG Simulator*** Use this mode to produce calibrated test signals such as pulse, square, sine and physiological waveforms which are useful in testing patient monitoring systems.

2.3 Safety Test Standards

vPad-ES may be used to perform electrical safety tests of medical devices with patient leads, following NFPA® 99, AAMI-ES1 and IEC60601-1 standards. TABLE 2.3-1 relates test nomenclature displayed by vPad-ES to nomenclature of the standards. TABLE 2.3-2 defines additional terms which pertain in general to electrical safety testing of medical equipment.

TABLE 2.3-1: Safety Test Nomenclature

vPad-ES	NFPA 99:2012	AAMI-ES1:1993	IEC60601-1:2007 (Ed. 3)
Line voltage Hot (L1) Neutral (L2) Ground (G)	Line Voltage Hot (H) Neutral (N) Ground (G)	Line Voltage Hot (H) Neutral (N) Ground (G)	Mains voltage Line 1 (L1) Line 2 (L2) Protective earth (PE)
Line cord resistance	Power cord resistance	(n / a)	Protective earth resistance
Chassis leakage current	Touch current	Enclosure risk current	Touch current
Ground leakage current	(n / a)	Earth risk current	Earth leakage current
Lead leakage to ground (GND)	Lead leakage current	Patient-applied risk current, source	Patient leakage current
Lead-to-lead leakage	(n / a)	Patient-applied risk current, source	Auxiliary leakage current
Lead isolation test	(n / a)	Patient-applied risk current, sink	Mains-on-applied-part (MAP) test

TABLE 2.3-2: Safety Test Terminology

Term	Definition
EUT	Equipment Under Test
NC	Normal operating condition. AC supply to EUT has ground and neutral both normal (closed).
SFC	Single-Fault Condition. AC supply to EUT has ground <i>or</i> neutral disconnected (open).
AP	Applied Part(s). IEC term referring to patient / ECG leads of EUT
Type B	IEC applied part protection class, type "Body" (non-isolated)
Type BF	IEC applied part protection class, type "Body-Floating" (isolated)
Type CF	IEC applied part protection class, type "Cardiac-Floating" (isolated, rated for direct cardiac application)

Leakage current testing is performed by connecting a measuring device, or "**MD**", to the EUT chassis and/or patient leads. vPad-ES incorporates measuring devices specified by AAMI and IEC standards, which are shown in **Figure 2**. Each MD incorporates a low-pass filter between the 1k test resistance and millivoltmeter to compensate for an allowable increase in leakage limits with increasing frequency.

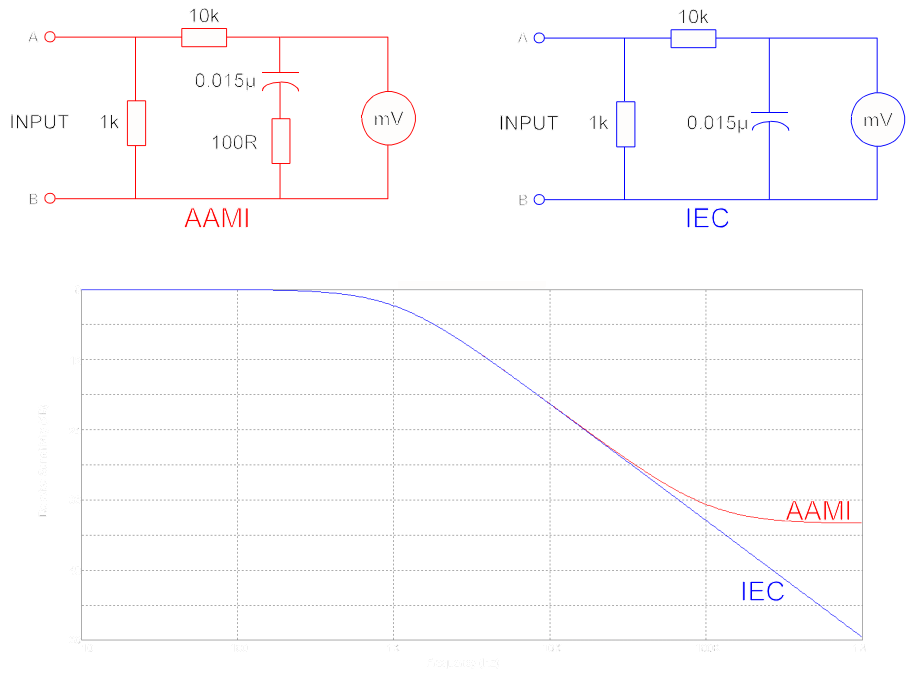

Figure 2 - Measuring devices (MD) for AAMI and IEC standards.

In addition to differences in the measuring device, NFPA, AAMI and IEC safety standards specify different

vPad-ES OPERATORS MANUAL

testing methods, which are summarized in TABLE 2.3-3. vPad-ES encompasses requirements of the standards by providing the necessary test settings that enable you to follow the standard of your choice.

TABLE 2.3-3: Leakage Test Requirements by Standard

Leakage Test	NFPA 99:2012	AAMI-ES1:1993	IEC60601-1:2007 (Ed. 3)
Chassis	<ul style="list-style-type: none"> • Test with EUT ON and OFF • Test normal polarity only • Test SFC open ground only 	<ul style="list-style-type: none"> • Test with EUT ON and OFF • Test normal/reverse polarity • Test normal condition (NC) • Test SFC, open ground 	<ul style="list-style-type: none"> • Test with EUT ON and OFF • Test normal/reverse polarity • Test normal condition (NC) • Test SFC, open ground • Test SFC, open neutral • Test with AP floating and to PE
Ground	Not required	<ul style="list-style-type: none"> • Test with EUT ON and OFF • Test normal/reverse polarity • Test normal condition (NC) • Test SFC, open neutral 	<ul style="list-style-type: none"> • Test with EUT ON and OFF • Test normal/reverse polarity • Test normal condition (NC) • Test SFC, open neutral • Test with AP floating and to PE
Lead(s) to Ground	<ul style="list-style-type: none"> • Test with EUT ON and OFF • Test normal polarity only • Test normal condition (NC) • Test SFC, open ground • Test all leads shorted 	<ul style="list-style-type: none"> • Test with EUT ON and OFF • Test normal/reverse polarity • Test normal condition (NC) • Test SFC, open ground • Test all leads shorted together • Test each lead individually 	<ul style="list-style-type: none"> • Test with EUT ON and OFF • Test normal/reverse polarity • Test normal condition (NC) • Test SFC, open ground • Test SFC, open neutral • Test APs in groups, by medical function <ul style="list-style-type: none"> - Type B: test whole group shorted - Type BF: test whole group shorted - Type CF: test each AP individually • Test total leakage, by protection class <ul style="list-style-type: none"> - Test all B AP's shorted together - Test all BF AP's shorted together - Test all CF AP's shorted together
Lead-to-lead(s)	Not required	<ul style="list-style-type: none"> • Test with EUT ON and OFF • Test normal/reverse polarity • Test normal condition (NC) • Test SFC, open ground • Test each lead to all others shorted together 	<ul style="list-style-type: none"> • Test with EUT ON and OFF • Test normal/reverse polarity • Test normal condition (NC) • Test SFC, open ground • Test SFC, open neutral • Test each AP to all others shorted together

vPad-ES OPERATORS MANUAL

Leakage Test	NFPA 99:2012	AAMI-ES1:1993	IEC60601-1:2007 (Ed. 3)
Lead isolation test	Not required	<ul style="list-style-type: none"> • Test with EUT ON and OFF • Test normal/reverse polarity • Test each lead individually 	<ul style="list-style-type: none"> • Test with EUT ON and OFF • Test normal/reverse polarity • Test APs in groups, by medical function <ul style="list-style-type: none"> - Type BF: test whole group shorted - Type CF: test each AP individually • Test total leakage, by protection class <ul style="list-style-type: none"> - Test all BF AP's shorted together - Test all CF AP's shorted together

Acceptance limits differ according to safety standard. TABLE 2.3-4 may be used as a reference when performing safety tests with vPad-ES.

Note the following with respect to TABLE 2.3-4:

- EUT ON or OFF and supply polarity reversed are considered to be normal operating conditions and have no bearing on limits specified.
- RMS values are listed for cord-connected equipment with a ground conductor (Class I), having isolated patient connections of protection class Type CF. Refer to the standard of interest for alternative limits if any of the following apply to the EUT or testing method:
 - DC-only leakage measurement
 - Cord-connected equipment without ground conductor (IEC Class II)
 - Non-isolated patient leads (IEC Type B)
 - Patient leads of IEC protection class Type BF (body-floating, isolated)
 - Permanently-installed equipment
 - Self-powered (battery) equipment

TABLE 2.3-4: Maximum Limits by Standard

Test	NFPA 99:2012	AAMI-ES1:1993	IEC60601-1:2007 (Ed. 3)
Line cord resistance	0.5 Ω	Not specified	0.2 Ω
Chassis leakage	NC: 100 μA SFC: 500 μA	NC: 100 μA SFC: 300 μA	NC: 100 μA SFC: 500 μA
Ground leakage	Not specified	NC: 500 μA SFC: 1000 μA	NC: 5,000 μA SFC: 10,000 μA
Lead to ground leakage	All leads shorted: NC: 100 μA SFC: 500 μA	All leads shorted, or each lead tested individually: NC: 10 μA SFC: 50 μA	Each lead tested individually: NC: 10 μA SFC: 50 μA All leads shorted (total leakage): NC: 50 μA SFC: 100 μA
Lead-to-lead leakage	Not specified	Each lead tested individually: NC: 10 μA SFC: 50 μA	Each lead tested individually NC: 10 μA SFC: 50 μA
Lead isolation test	Not specified	Each lead tested individually: 50 μA	Each lead tested individually: 50 μA All leads shorted (total leakage): 100 μA

Note: vPad-ES is a manual safety analyzer and does NOT automatically assess a PASS or FAIL based on the limits of TABLE 2.3-4. For automated electrical safety testing, including automatic pass/fail assessment, the optional vPad-AS application may be used. For more information, see

www.datrend.com/index.php?page=vpad-es

vPad-ES OPERATORS MANUAL

3 Setup

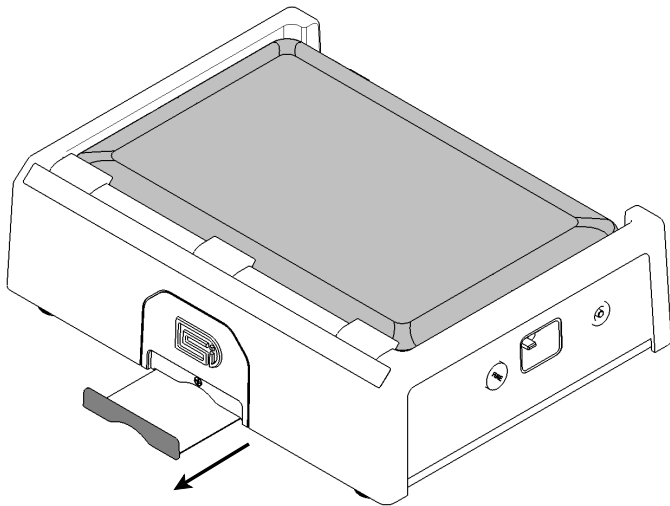

Figure 3

After placing the Analyzer Base Unit on a stable, flat surface, pull out the tablet tray on the front of the unit.

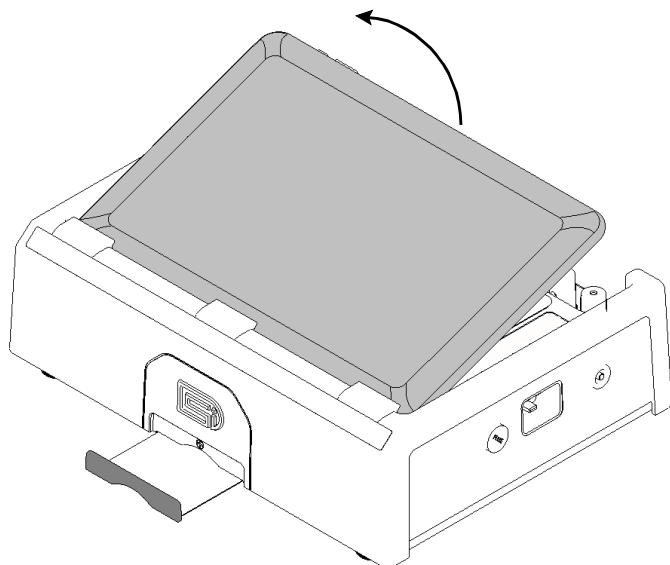

Figure 4

At the back of the Base Unit above the binding posts, grab the tablet and carefully lift it away from the unit.

vPad-ES OPERATORS MANUAL

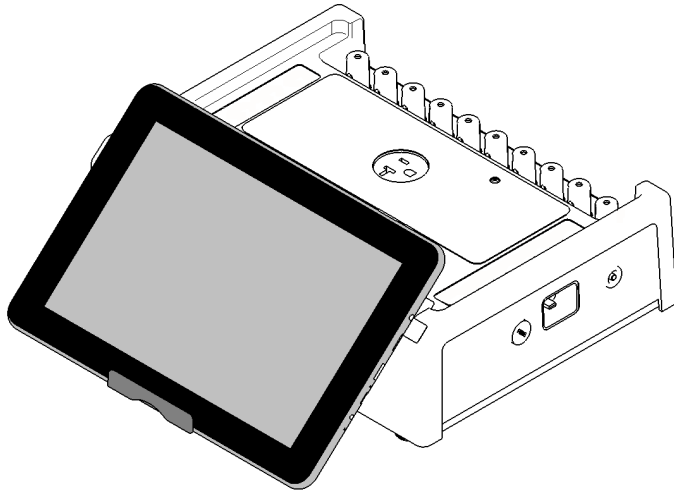

Figure 5

Place the bottom of the tablet on the tray and rest the rear of the tablet on the front of the base unit.

The tablet may also be held in place without the tray, using the inherent ‘sticky’ characteristics of the labels on the back of the tablet and the front of the base unit.

Connect the power cable from the TABLET DC jack of the Base Unit to the DC IN jack of the tablet. The cable provided with vPad-ES will depend on tablet model: 12V (P/N 3140-476) or 5V (P/N 3140-477).

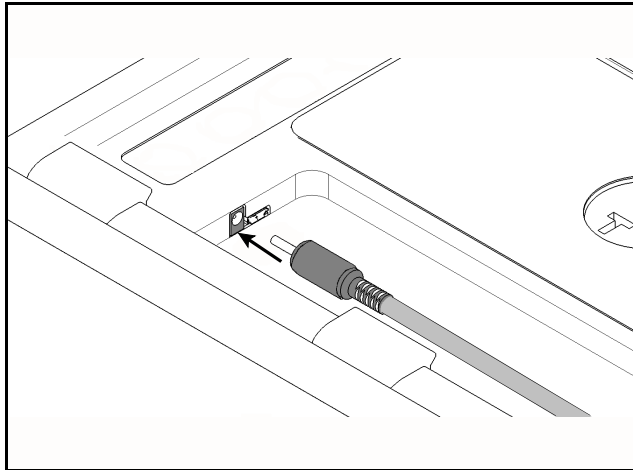

Figure 6

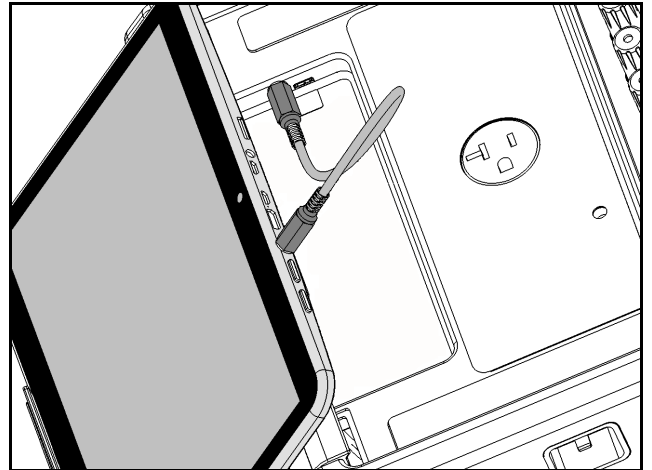

Figure 7

vPad-ES OPERATORS MANUAL

Connect the USB cable provided with vPad-ES (P/N 3140-478) from the TABLET USB jack of the Base Unit to the USB port of the tablet.

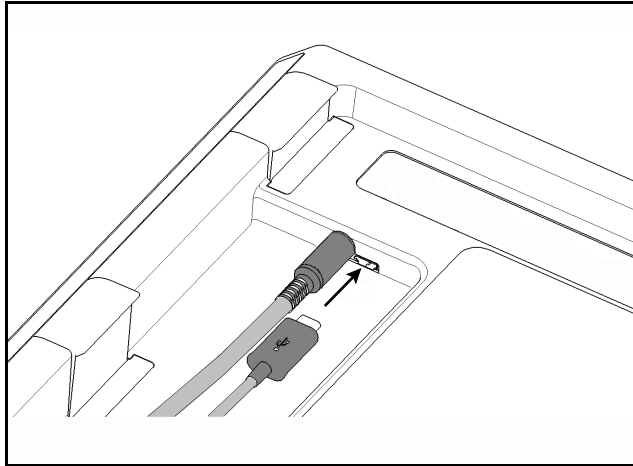

Figure 8

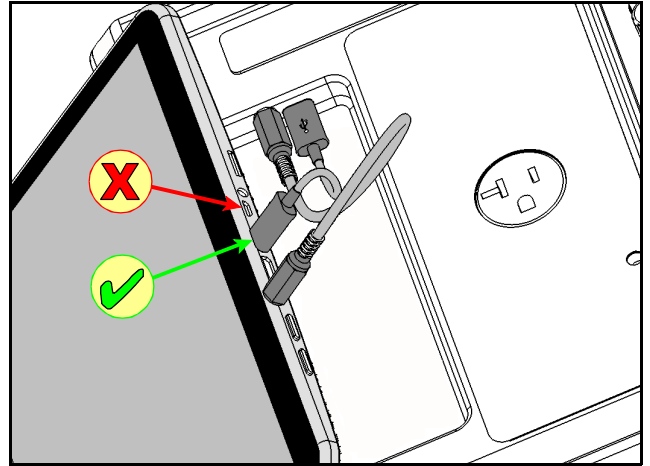

Figure 9

Connect the power cord provided with vPad-ES to the right side panel of the unit, then plug the cord into a power outlet (*Figure 10*). If the AC outlet has power, the indicator lamp on the left panel of the Analyzer Base Unit should now be lit (*Figure 11*).

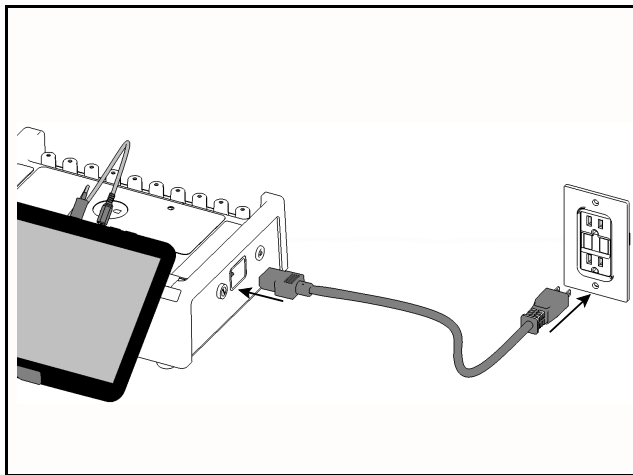

Figure 10

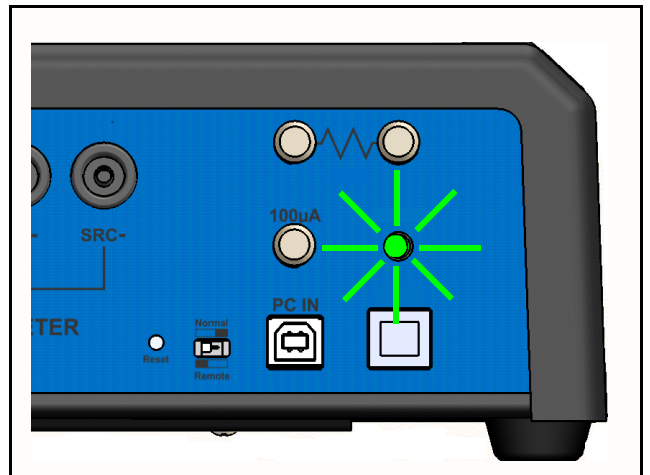

Figure 11

vPad-ES OPERATORS MANUAL

With the Base Unit now powered up, switch the tablet ON by pressing and holding the power button on the top of the tablet until the tablet is felt to vibrate (approx. 5 - 10 sec). Approximately 60 seconds after switching ON, the Android HOME screen should appear on the tablet.

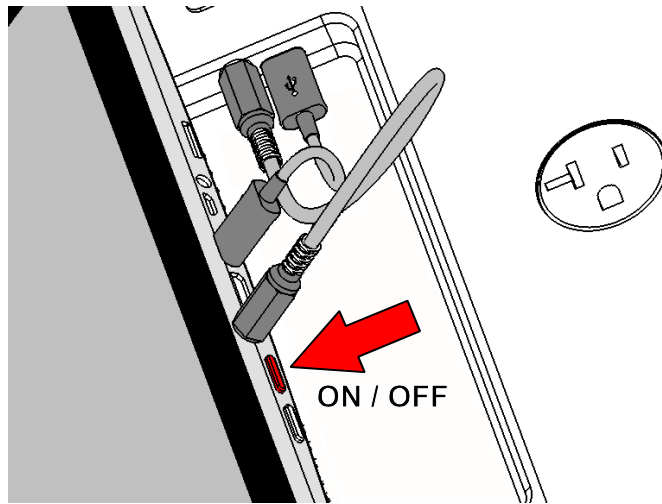

Figure 12

The foregoing instructions are for the standard tablet model. Alternative tablet models may have DC and USB connections and the Power button in different locations; one example is shown in *Figure 13*. If necessary, refer to the tablet operator manual provided with vPad-ES for further guidance.

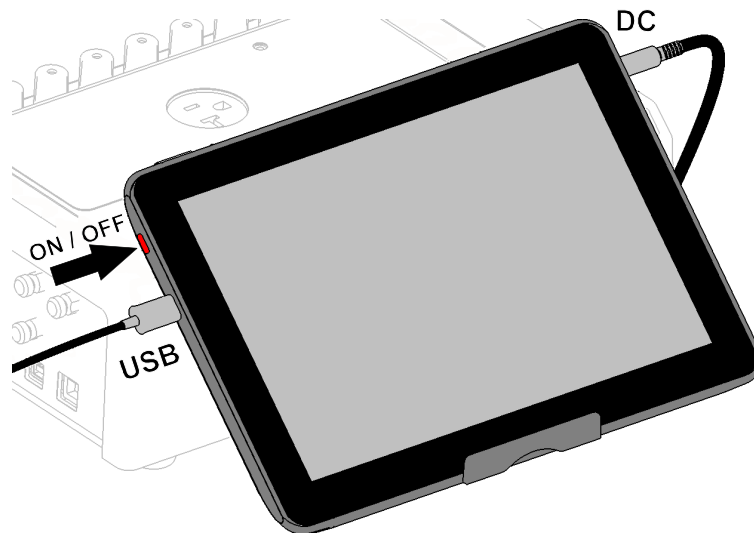

Figure 13

vPad-ES OPERATORS MANUAL

Switch the tablet OFF when vPad-ES is not in use. Press and hold the ON/OFF switch until a confirmation message appears on the tablet screen. Select the appropriate response to complete the Power Off sequence.

Note: Pressing and releasing the Power ON/OFF button momentarily will put the tablet in a 'sleep' mode. Press the ON/OFF button momentarily again to 'wake' the tablet. This is NOT the same as OFF.

To store or transport vPad-ES, reverse the setup procedure by starting at *Figure 10* and proceeding to *Figure 3* above.

vPad-ES OPERATORS MANUAL

4 Operation

This chapter explains how to use vPad-ES to perform electrical safety tests and inspections of medical equipment. Test Record management is also covered in this chapter.

4.1 HOME Screen

The Android HOME screen (*Figure 14*) is displayed approximately 60 seconds after switching the tablet ON.



Figure 14 - HOME screen.

vPad-ES OPERATORS MANUAL

Initiate actions on the tablet by pressing the corresponding icon or button. For example:



Press to launch the vPad-ES software application, or "**app**". Use this app to perform electrical safety testing.



Press to launch the vPad Record Manager app. Use this app to copy, print, convert or delete Test Records saved by vPad-ES.



Press to access Settings. Use this menu to configure sound, display, touchscreen, and wireless setup.



By default, vPad-ES is supplied with both WiFi and Bluetooth connectivity ***disabled***. Use the Settings menu to enable wireless connectivity, in accordance with policies of your institution or organization.



At top right on the screen, press the **Apps** button to access more apps which are installed on the tablet.



At bottom left on the screen, press the **Home** button to return from an app to the Home screen.



At bottom left, press the **Back** button to navigate back one step, from the app or screen currently being displayed, to a previous one. For some apps, this button's function may be disabled.



At bottom left, press the **Recents** button to jump from the current app to a different app that was started earlier, but is currently on pause

For more information on how to use the Android tablet, refer to the tablet operator manual supplied with vPad-ES.

4.2 Startup

Press the vPad-ES icon on the Android Home screen to start the app. A splash screen will display the product name and the software version.



Figure 15 - vPad-ES startup screen.

As the splash screen is displayed, the app will "connect" to the Analyzer Base Unit and cause it to perform a number of internal self-tests. The AC supply which powers vPad-ES is also tested. Normally, all tests will complete successfully and the main activity of the app will then be displayed.

Faults in the Base Unit or the AC supply may be detected during the self-test, in which case an alarm message is displayed below the software version number. In the event of a Base Unit fault, the app will automatically exit to the Home screen. In the event of an AC supply fault, in addition to the alarm message the app will display an Alert Dialog, which you must then acknowledge by pressing "Continue", "Exit" or "OK" (see *Figure 16*). Refer to TABLE 4.2-1 for recommended actions in the event of a startup alarm message.

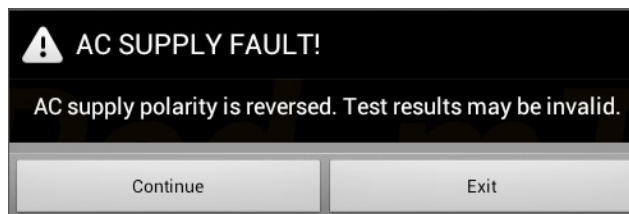

Figure 16 - Alert Dialog: AC supply fault.

TABLE 4.2-1: Startup Alarms and Corrective Actions

vPad-ES OPERATORS MANUAL

Alarm Message	Cause	Actions
ERROR: cannot communicate with Base Unit	App is unable to send messages to one or more instrument systems inside the Base Unit	<ul style="list-style-type: none"> • Check Base Unit has power (check power indicator, left panel - see Figure 1 on page 10) • Check Base-to-tablet USB connection (see Figure 9 on page 23) • If AC power and USB cables are OK, press and hold RESET button of Figure 1 for 3 seconds, then try restarting the app • If error persists, contact Datrend Customer Service (see Chapter 5 for contact information)
AC SUPPLY FAULT (polarity reversed)	AC outlet incorrectly wired	<ul style="list-style-type: none"> • Do not use vPad-ES with incorrect or unsafe AC supply • Connect Base Unit to a different outlet
AC SUPPLY FAULT (ground disconnected)	AC outlet incorrectly wired	<ul style="list-style-type: none"> • Do not use vPad-ES with incorrect or unsafe AC supply • Connect Base Unit to a different outlet
AC SUPPLY FAULT (ground disconnected)	Isolated power system	<ul style="list-style-type: none"> • Do not perform leakage testing as results will be invalid • Optionally, vPad-ES may be used to perform tests other than leakage (e.g., voltage, resistance or ECG simulator tests) • If possible, change to grounded power outlet
RMS zero calibration failure	Unable to zero voltmeter	<ul style="list-style-type: none"> • Press RESET button of Figure 1 for 3 seconds, then try restarting app • If problem persists, contact Datrend Customer Service (see Chapter 5 for contact information)

4.3 Test Navigation

After startup, the main menu of vPad-ES is displayed. Tabs at the top of the screen navigate between the test modes provided by vPad-ES. By default, vPad-ES selects the Voltage tab after startup. To select a different test mode, press the corresponding tab.



Figure 17 - Test Tabs.

4.4 Receptacle Control



This section contains important information which relates to operator safety. Read and follow all instructions.

Voltage, Resistance and Simulator test modes provide a button which you may press to switch the test receptacle ON or OFF as required. The Equipment Inspection menu also provides this control.



Figure 18 - Test receptacle power button.

For convenience, vPad-ES automatically switches the receptacle **ON** when you select Equipment Load, Leakage or Patient Lead mode.

By default, vPad-ES automatically switches the receptacle **OFF** if you change test mode to Voltage, Resistance or ECG Simulator. If desired, this default behaviour can be overridden via the vPad-ES Settings menu; refer to Section 4.10 for details.

vPad-ES OPERATORS MANUAL

Android navigation buttons override the app display but do not necessarily *stop* what an app may be doing. If the test receptacle is **ON**, and you navigate away from vPad-ES by pressing:

Home  , or

Recent 

the test receptacle will remain **ON**. A characteristic of Android is that once an app such as vPad-ES is launched, the app *may keep running*, even if the app's display is partly or completely obscured by another app or the Android Home screen.

While viewing Voltage, Leakage and other test displays of vPad-ES, the Android "Back" button  may be pressed to completely close the application. Since unsaved measurement data will be lost if vPad-ES is closed, a warning dialog is displayed which will allow you to exit or otherwise keep the application running. When vPad-ES is closed, the test receptacle is switched **OFF** automatically. Note the Android "Back" button is enabled on the test displays, but is disabled when viewing smaller pop-up menus such as Save Data, which typically have a dedicated "Cancel" button for exiting the pop-up.

For safest operation of vPad-ES, follow these instructions:

- Before connecting or disconnecting equipment, observe the **Receptacle Active** lamp (*Figure 1*, page 10). Use caution when the **Receptacle Active** lamp is lit.
- Switch the test receptacle **OFF** when not in use
- Do not disable the Receptacle Auto-OFF setting unless the EUT or test requires that the AC supply must be continuously ON
- Before launching a new application, press the Android "Back" button  and respond "YES" to the displayed message. This will close vPad-ES and switch the test receptacle **OFF**.



4.5 Voltage Tests

Following application startup, vPad-ES defaults to measurement of the AC supply or "line voltage", from Line 1 (L1) to Line (L2).

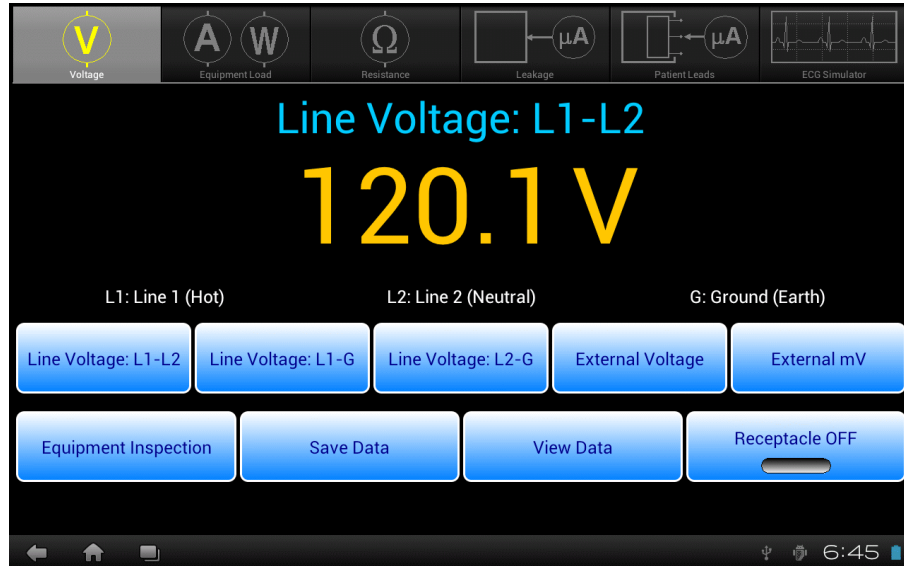

Figure 19 - Voltage test mode.

This test mode enables measurement of three different voltages associated with the AC supply, and two external or point-to-point voltages. As selected by the upper row of buttons, the voltage currently under test is indicated immediately above the numeric readout. Voltage is continuously measured and displayed until a different test mode is selected. The bottom row of buttons provides these functions:

<i>Equipment Inspection</i>	Press to launch the equipment inspection procedure. See Section 4.12 for instructions.
<i>Save Data</i>	Press to save the voltage measurement currently being displayed. Refer to Section 4.13 for instructions on data recording.
<i>View Data</i>	Press to review measurement data recorded during testing.
<i>Receptacle ON/OFF</i>	Press to switch the test receptacle ON or OFF as desired. Refer to Section 4.4 for important information and instructions concerning operation of the test receptacle.

Sections 4.5.1 to 4.5.3 provide instructions for the Voltage test mode.

4.5.1 Line Voltage

Press the corresponding **Line Voltage** button to measure the desired potential per *Figure 20* to *Figure 22*. No external test leads are necessary. Voltages are measured over a range of 90-264 VAC.

With respect to the illustrations, note the following:

- Line 1 (L1) = AC supply Hot (H)
- Line 2 (L2) = AC supply Neutral (N)
- Earth (E) = AC supply Ground (G)

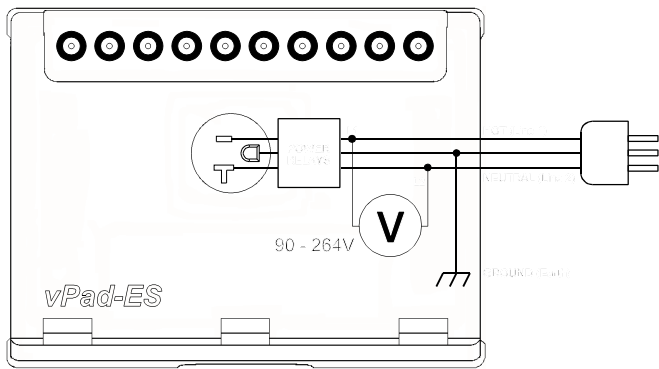

Figure 20 - Line voltage test, L1-L2 (hot-neutral).

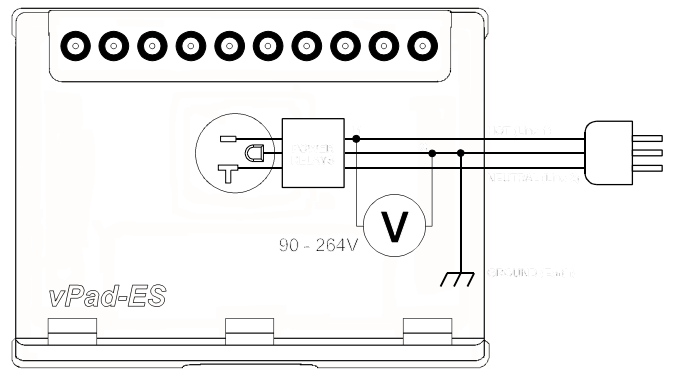

Figure 21 - Line voltage test, L1-G (hot-ground).

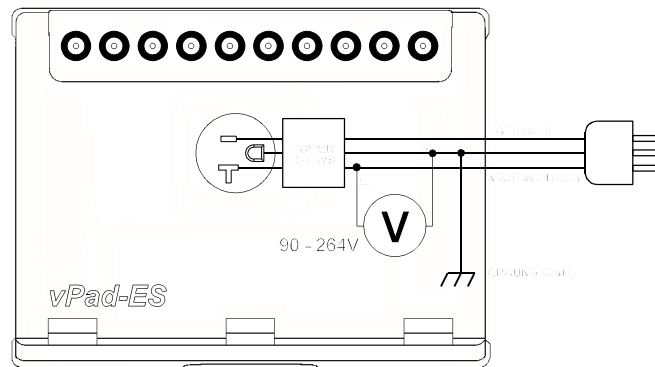

Figure 22 - Line voltage test, L2-G (neutral-ground).

If the AC supply which powers vPad-ES is correctly wired and is not connected to an isolated power distribution, potentials L1-L2 and L1-G should be approximately equal, and potential L2-G should be substantially smaller than L1-L2.

4.5.2 External Voltage

Press the **External Voltage** button to measure large voltages between two arbitrary points, typically 20V, up to a maximum of 300V.

Connect test leads to the voltmeter at **EXT+** and **EXT-** jacks on the left panel of the Analyzer Base Unit. You may use standard multimeter (DMM) probes, or alternatively two vPad Kelvin Cables, as respectively shown in *Figure 23* and *Figure 24* following.

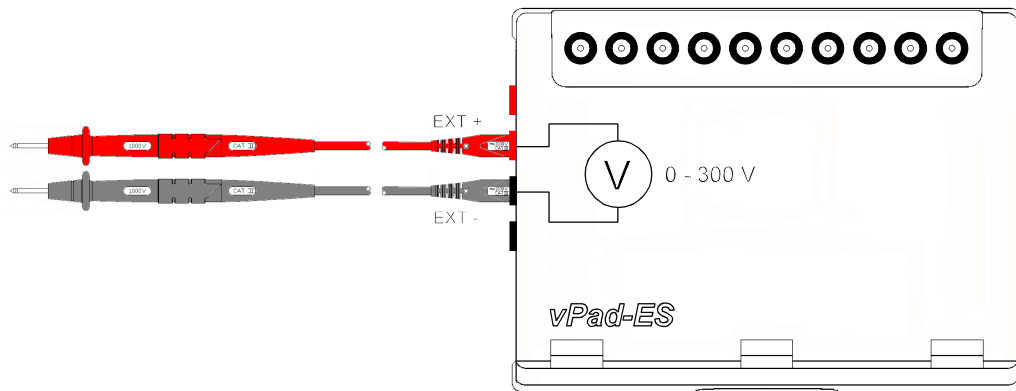

Figure 23 - External voltage test with two DMM probes.

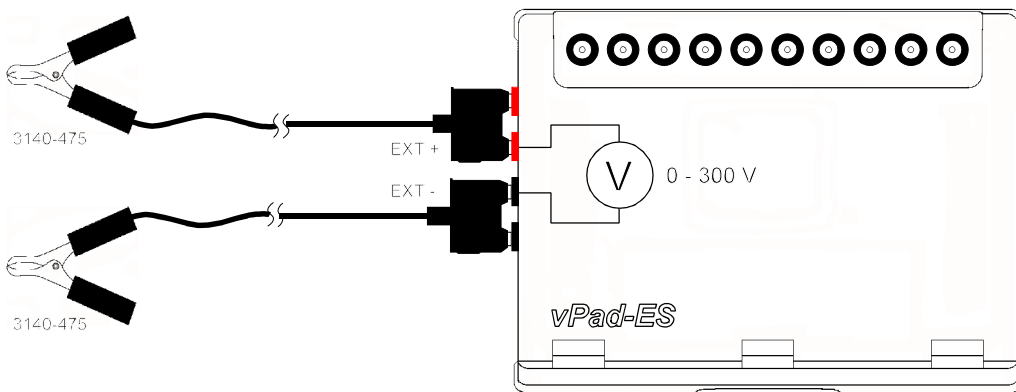

Figure 24 - External voltage test with two Kelvin Cables.

4.5.3 External Micropotential

Press the **External mV** button to measure small potentials in the millivolt range between two arbitrary points, up to a maximum of 20V.

When you select this test, an Alert Dialog is displayed to remind you of vPad-ES maximum ratings. Press "OK" to clear the Alert Dialog and begin testing, or "Cancel" to abort and return to the previous test mode.

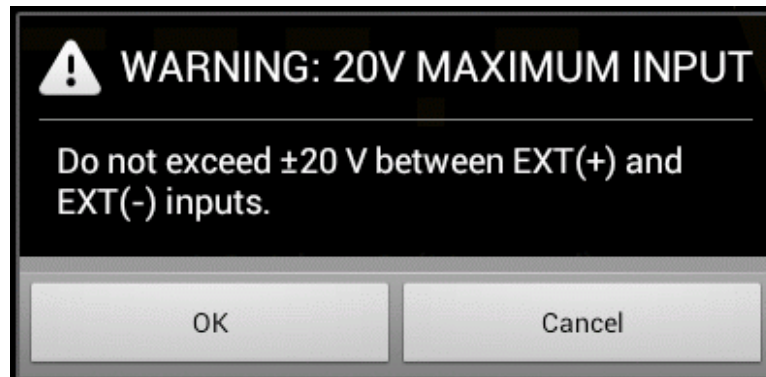



Figure 25 - Alert Dialog - maximum input 20V.

	Exceeding specified maximum ratings may result in damage to vPad-ES and is not covered by warranty.
---	---

vPad-ES OPERATORS MANUAL

Connect test leads to the voltmeter at **EXT+** and **EXT-** jacks on the left panel of the Analyzer Base Unit. You may connect to external points using two standard multimeter (DMM) probes, or two vPad Kelvin Cables as shown in **Figure 26**. If points are less than 1" (2 cm) apart, a single Kelvin Cable may optionally be used, as shown in **Figure 27**.

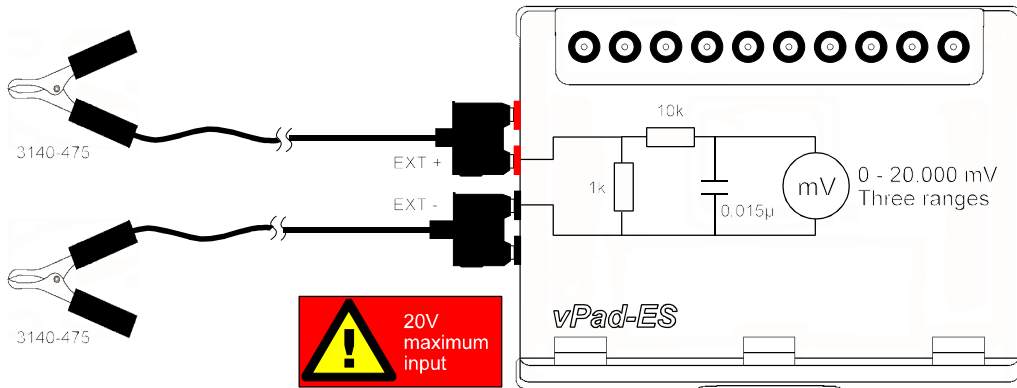

Figure 26 - External micropotential test with 2 x Kelvin cable.

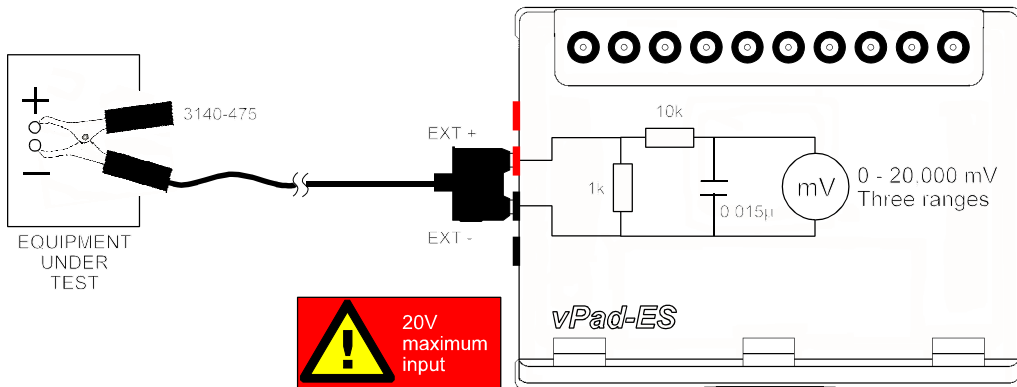

Figure 27 - External micropotential test with one Kelvin cable.

According to the above schematics, external micropotential is measured with an IEC measuring device. Range is automatically selected by vPad-ES to suit the voltage being measured (200, 2000 or 20000 mV full scale).

4.6 Equipment Load Tests

Select Equipment Load test mode by pressing the corresponding tab at the top of the screen. When this mode is selected, the test receptacle is switched **ON** automatically. Refer to Section 4.4 for important information and instructions concerning operation of the test receptacle.

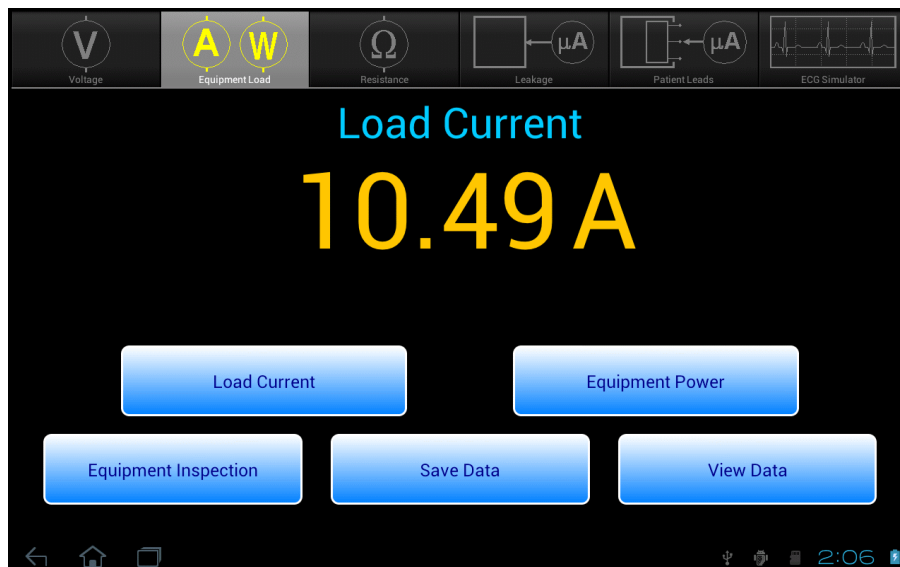

Figure 28 - Load test mode.

This test mode enables you to measure AC supply current of the equipment under test (EUT), and power consumption. The upper two buttons select the test, which is indicated immediately above the numeric readout. AC current or power is continuously measured and displayed until a different test mode is selected. The bottom row of buttons provide these functions:

- | | |
|------------------------------------|--|
| <i>Equipment Inspection</i> | Press to launch the equipment inspection procedure. See Section 4.12 for instructions. |
| <i>Save Data</i> | Press to save the measurement value currently being displayed. Refer to Section 4.13 for instructions on data recording. |
| <i>View Data</i> | Press to review measurement data recorded during testing. |

Sections 4.6.1 and 4.6.2 provide instructions for the Equipment Load test mode.

4.6.1 Load Current

Connect the EUT to the test receptacle and press the **Load Current** button to place an AC ammeter in series with the EUT (**Figure 29**). No external test leads are necessary. AC current is measured up to 2A or 20A, with the range being automatically selected by vPad-ES as required.

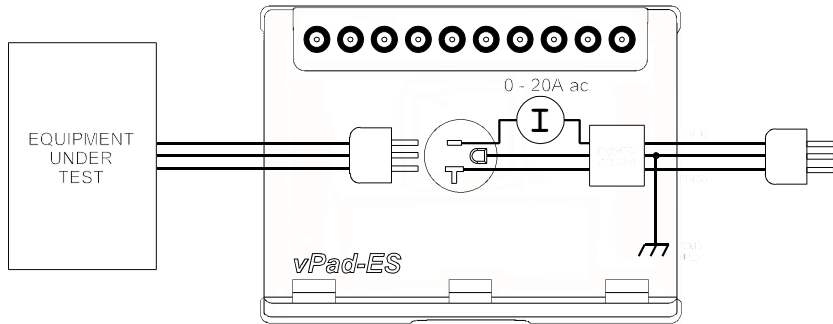

Figure 29 - Load current test.

4.6.2 Power Consumption

With the EUT connected to the test receptacle, press the **Equipment Power** button to measure EUT power consumption (**Figure 30**). No external test leads are necessary. vPad-ES derives power by measuring the load current, then the line voltage L1-L2, and multiplying the results: power = voltage x current.

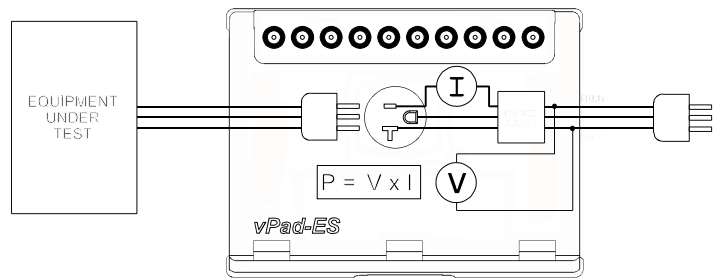

Figure 30 - Power consumption test.

Considering specified tolerances of voltage and current measurements, this test mode is most useful when measuring loads which draw 50W of power or higher. Examples would include lamps, heaters, ovens, fans and other equipment incorporating larger induction motors or pumps.

4.7 Resistance Tests

Select Resistance test mode by pressing the corresponding tab at the top of the screen.

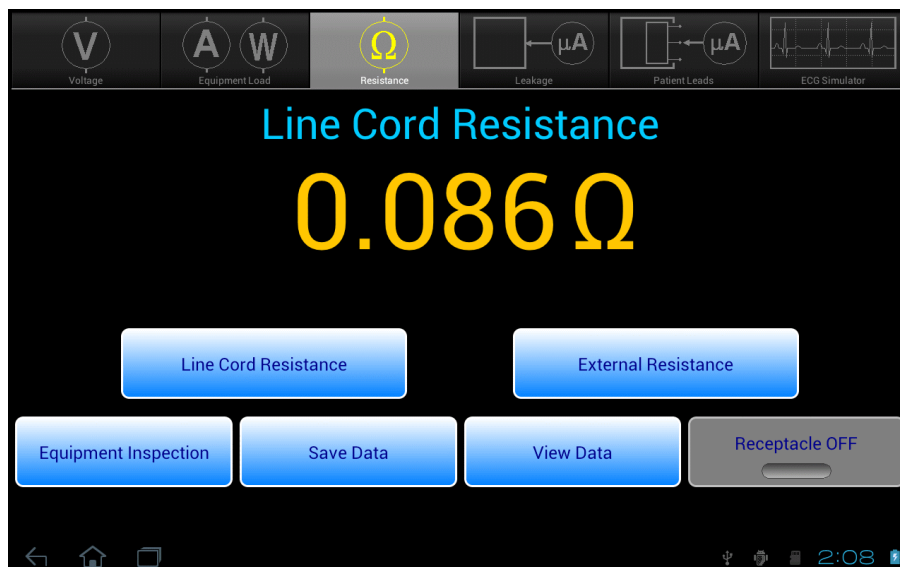

Figure 31 - Resistance test mode.

This mode enables measurement of resistance of the line cord which conveys AC power to the equipment under test (EUT). Point-to-point (External) resistance may also be measured. The upper two buttons select the resistance test, which is indicated immediately above the numeric readout. Resistance is continuously measured and displayed until a different test mode is selected. The bottom row of buttons provides these functions:

<i>Equipment Inspection</i>	Press to launch the equipment inspection procedure. See Section 4.12 for instructions.
<i>Save Data</i>	Press to save the resistance value currently being displayed. Refer to Section 4.13 for instructions on data recording.
<i>View Data</i>	Press to review measurement data recorded during testing.
<i>Receptacle ON/OFF</i>	Press to switch the test receptacle ON or OFF as desired. Refer to Section 4.4 for important information and instructions concerning operation of the test receptacle. For safety, this button is disabled when measuring resistance of the EUT power cord.

Sections 4.7.1 and 4.7.2 provide instructions for the Resistance test mode.

4.7.1 Line Cord Resistance

Press the **Line Cord Resistance** button to measure the resistance from the EUT chassis to the ground pin on the plug of the EUT's line cord. This test is the default on entry to the Resistance mode.

An Alert Dialog is displayed if the test receptacle is **ON** when this test is selected. Press "**OK**" when you are ready to power down the EUT and proceed with the resistance test.



Figure 32 - Alert Dialog - EUT will be powered OFF for test.

Connect the EUT line cord to the test receptacle. Plug the vPad Kelvin Cable into **SRC+** and **EXT+** jacks on the left panel of the Analyzer Base Unit, then connect the Kelvin Cable to a grounded terminal or conductive point on the EUT chassis (*Figure 33*).

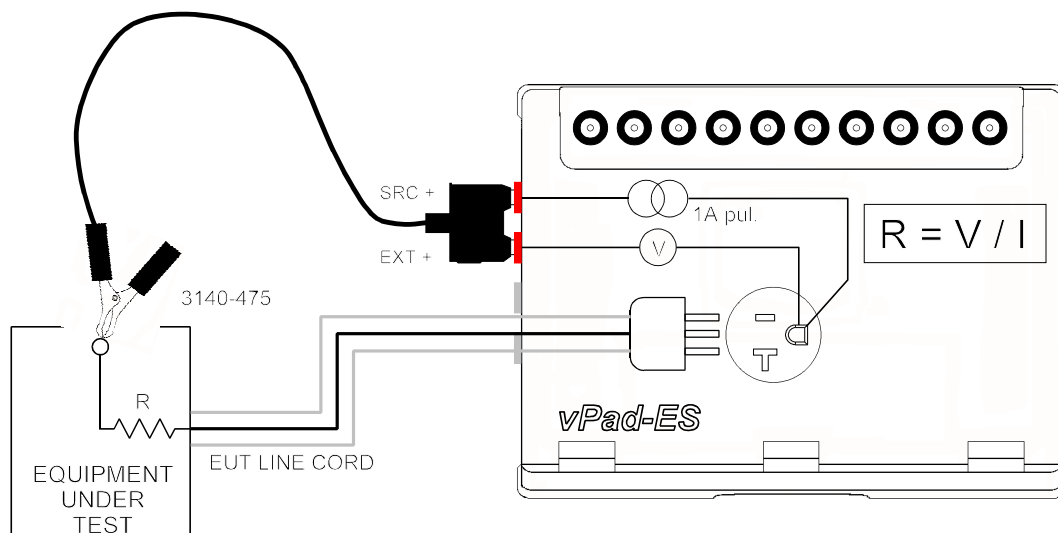

Figure 33 - Line cord resistance test.

vPad-ES OPERATORS MANUAL

Resistance is measured up to 2 Ω . If vPad-ES indicates **X.XX**, the resistance exceeds 2 Ω and may be open-circuit. When the display shows **X.XX**, a poor connection to the EUT chassis may be the problem; inspect attachment of the Kelvin Cable or move the cable to a different point on the chassis.

Note that all exposed metal is not necessarily connected to ground.

Avoid connecting the Kelvin Cable to "functional earth" (FE) terminals on the EUT. FE terminals are zero-reference points for EUT input/output signals, and are not intended to provide protective grounding of medical equipment. Examples of FE include the grounded shell or frame of connectors used for computer interface (e.g. RS-232 Port; USB Port; etc.)

4.7.2 External Resistance

Press the **External Resistance** button to measure resistance between two arbitrary points. In this mode, the receptacle ON/OFF button is enabled so that the EUT may be powered up, if desired.

This test requires two vPad Kelvin Cables, connected as shown in **Figure 34**. Resistance up to 2 Ω may be measured. As with the line cord test, high resistance or open-circuit conditions are represented by **X.XX** on the display; inspect attachment of the Kelvin Cables in this case.

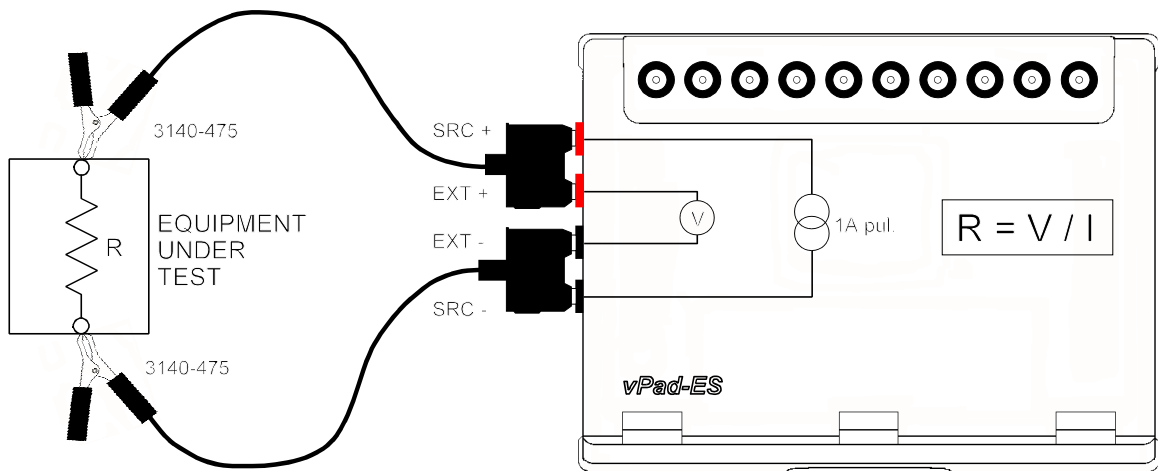

Figure 34 - External (point-to-point) resistance test.

4.7.3 Measurement Method

Referring to *Figure 33* and *Figure 34*, vPad-ES uses a "four-wire method" when measuring line cord or point-to-point resistance. Not apparent from the schematics are two separate insulated conductors in the Kelvin Cable, one conductor conveying a current (I) to the resistance under test (R), and the other conductor conveying voltage (V) caused by current (I) to a voltmeter. For known or measured current (I) and measured voltage (V), resistance can then be calculated as $R = V/I$. The four-wire method is preferred for measurement of small resistance values, since error caused by internal resistance of the test leads is eliminated.

The four-wire ohmmeter of vPad-ES uses a pulsed 1A (200 mA rms) current source. Both the current source and the voltmeter of vPad-ES are "floating", that is, isolated from ground of the AC supply. This permits vPad-ES to be used for measuring resistance between any two points, grounded or otherwise.

4.7.4 Test Application

If medical equipment is not double-insulated (IEC Class II), resistance of the line cord should be tested to at least one point of contact, or preferably to several different points, on the equipment chassis. Additionally, it may be necessary to test continuity from one conductive part of the equipment to another, for example, across the articulations of a hospital bed.

The maximum allowable resistance will depend on applicable electrical safety standards of your country or region. Commonly-used limits range from 0.2 to 0.5 Ω . Refer to Section 2.3, TABLE 2.3-4.

4.8 Leakage Tests

Select the Leakage test mode by pressing the corresponding tab at the top of the screen. The test receptacle will be switched **ON** automatically, in normal condition. Refer to Section 4.4 for important information and instructions concerning operation of the test receptacle.

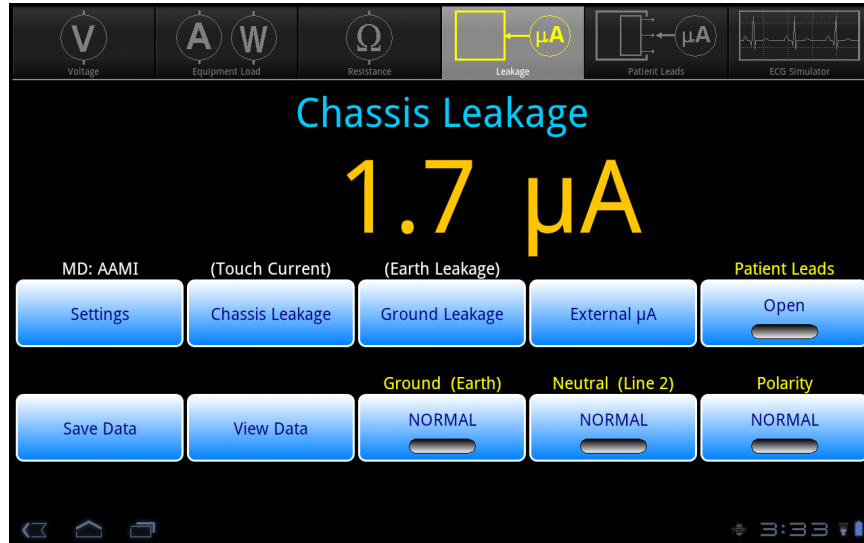

Figure 35 - Leakage test mode.

Note that prior use of the External Voltage test function (Section 4.5.2) will cause a warning to be displayed when Leakage test mode is initially selected. This warning prompts to user to confirm that a source of high voltage, which could have been under test by the External Voltage function and which could damage the safety analyzer if still active, has been disconnected from the EXT(+) input jack. The leakage meter of vPad-ES is not activated until the user acknowledges this warning with the "Continue" button.

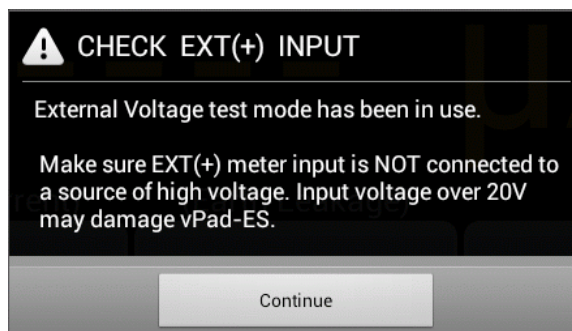

Figure 36 - Warning - check EXT(+) input.

vPad-ES OPERATORS MANUAL

The Leakage test mode enables measurement of Chassis and Ground Leakage currents (or, in IEC terminology, Touch Current and Earth Leakage respectively). External or point-to-point leakage may also be tested. As selected by the upper row of buttons, the type of leakage current under test is indicated immediately above the numeric readout. The leakage current is continuously measured and displayed until a different test mode is selected. The bottom row of buttons provide these functions:

<i>Save Data</i>	Press to save the leakage value currently being displayed. Refer to Section 4.13 for instructions on data recording.
<i>View Data</i>	Press to review measurement data recorded during testing.
<i>Ground (Earth)</i>	Press to toggle the ground of the test receptacle between "Normal" and "Open" conditions.
<i>Neutral (Line 2)</i>	Press to toggle the neutral of the test receptacle between "Normal" and "Open" conditions.
<i>Polarity</i>	Press to toggle the polarity of the test receptacle between "Normal" and "Reverse" conditions.

Sections 4.8.1 to 4.8.3 provide instructions for the Leakage test mode.

4.8.1 Chassis Leakage

Press the **Chassis Leakage** button to measure leakage current from the chassis or enclosure of the EUT to the ground of the AC supply. Chassis Leakage is the default upon selection of the Leakage test mode.

Connect the EUT to the test receptacle, and use the vPad Kelvin Cable to connect a conductive point on the EUT chassis to the **EXT+** jack on the left side of the Base Unit, as shown in **Figure 37**. Leakage current is measured over three ranges (200, 2000 or 20000 μA full scale), with the range being automatically selected by vPad-ES as required.

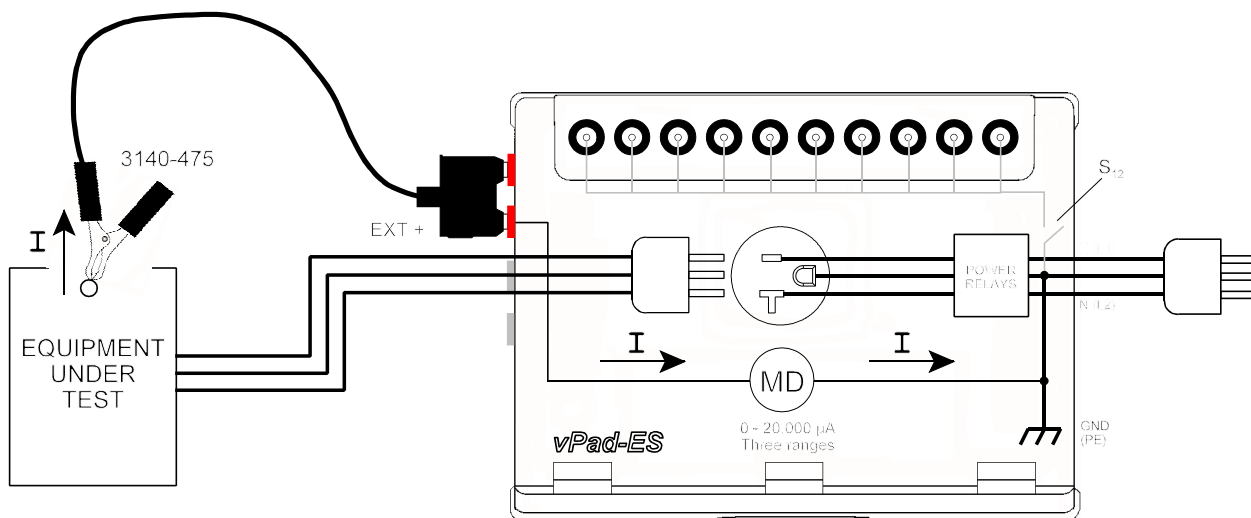

Figure 37 - Chassis leakage test.

Referring to the display screen shown in **Figure 35**, the **Patient Leads** button may be used to connect EUT patient leads or "applied parts" to the AC supply ground. This is represented in the schematic of **Figure 37** by switch S_{12} and is a test condition which is required by the IEC60601 standard. Pressing the **Settings** button of **Figure 35** allows you to choose AAMI or IEC measuring device (MD), and optionally choose AC-only or DC-only measurement; refer to Section 4.10 for more details on Leakage Settings.

Ground and **Neutral** controls of **Figure 35** are mutually exclusive and setting one of these to "Open" will cause the other to be automatically set to "Normal" if it is not already so. This prevents you from inadvertently selecting a double-fault test condition, which is not permitted in the safety standards.

Chassis leakage (touch current) may be tested for IEC Class I and Class II medical equipment. No special provisions are required when testing Class II, however, note the **Ground** control of the safety analyzer will have no influence on the test result since the EUT lacks a ground conductor in the line cord.

vPad-ES OPERATORS MANUAL

When **Polarity** is changed, the test receptacle is switched OFF for a period of time, after which the receptacle is then re-activated at the new polarity (see **Figure 38**). During the delay, receptacle controls are disabled. This time delay is necessary to prevent surges in supply current which could potentially damage the EUT and/or vPad-ES. A fixed two-second delay is used if **Neutral** is "Open" when **Polarity** is changed. If **Neutral** is in "Normal" condition when **Polarity** is changed, a user-selectable delay then applies which may be set over a range of 2 to 8 seconds using the Settings button; refer to Section 4.10 for details.

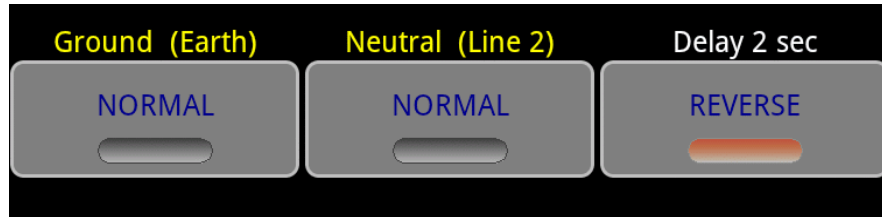

Figure 38 - Polarity change in progress.

4.8.2 Ground Leakage

Press the **Ground Leakage** button to measure leakage current which flows through the grounding conductor of the EUT. No external test leads are necessary. Leakage current is measured over three ranges (200, 2000 or 20000 μA full scale), with the range being automatically selected by vPad-ES, as required.



Figure 39 - Ground leakage display.

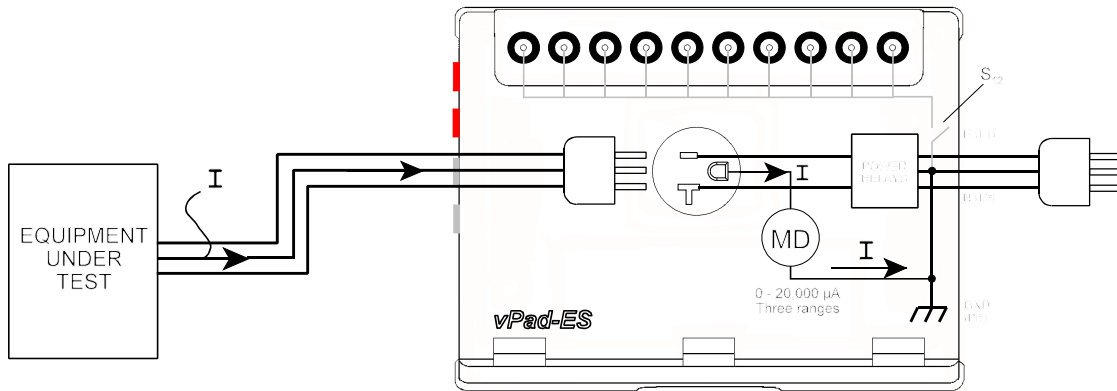

Figure 40 - Ground leakage test.

The **Ground** control is disabled for this test. Per AAMI and IEC test requirements, **Neutral** of the test receptacle may be set to "Open" as a single-fault condition. Note ground (earth) leakage testing is not applicable to IEC Class II medical equipment, since the EUT has no ground conductor to convey the current.

4.8.3 External Leakage

Press the **External µA** button to measure leakage current between two arbitrary points. The range is automatically selected by vPad-ES to suit the leakage being measured (200, 2000 or 20000 µA full scale).

When you select this test, an Alert Dialog is displayed to remind you of vPad-ES maximum ratings. Press "OK" to clear the Alert Dialog and begin testing, or "Cancel" to abort and return to the previous test mode.

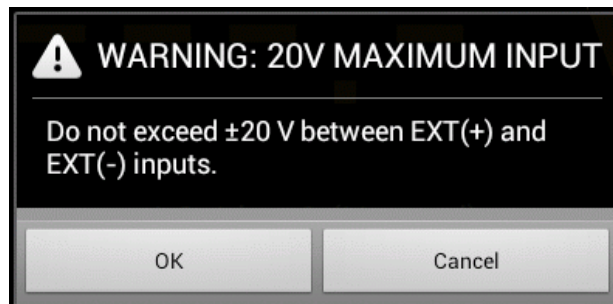

Figure 41 - Alert Dialog - maximum input 20V.

Exceeding specified maximum ratings may result in damage to vPad-ES and is not covered by warranty.

vPad-ES OPERATORS MANUAL

Connect test leads to the leakage measuring device at **EXT+** and **EXT-** jacks on the left panel of the Analyzer Base Unit. You may connect to external points using two vPad Kelvin Cables (*Figure 42*), or with standard multimeter probes (*Figure 43*). If points are less than 1" (2 cm) apart, a single Kelvin Cable may optionally be used, as shown in *Figure 44*.

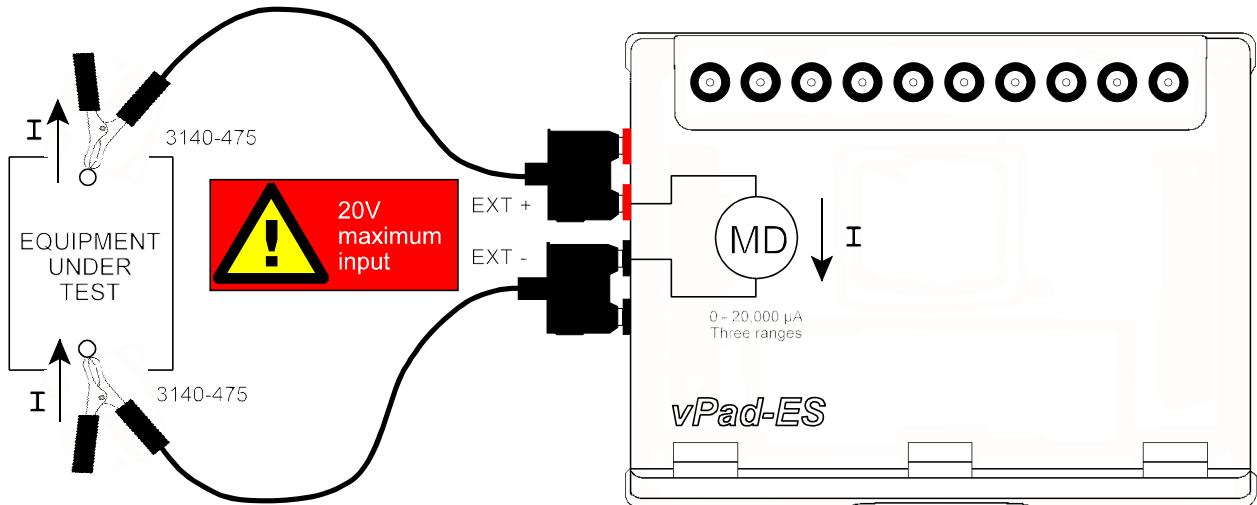

Figure 42 - External leakage test with two Kelvin Cables.

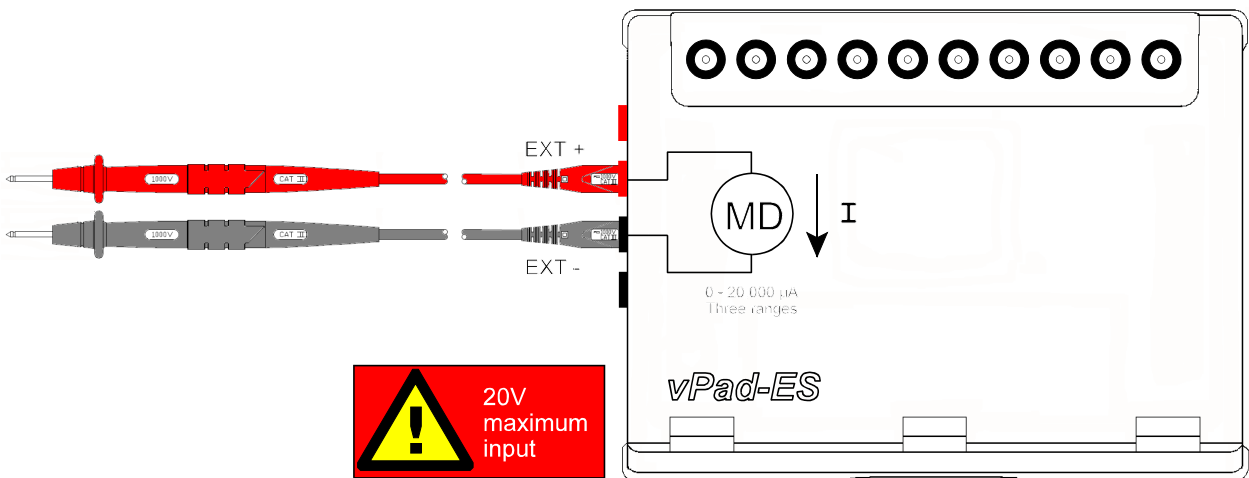

Figure 43 - External leakage test with two DMM probes.

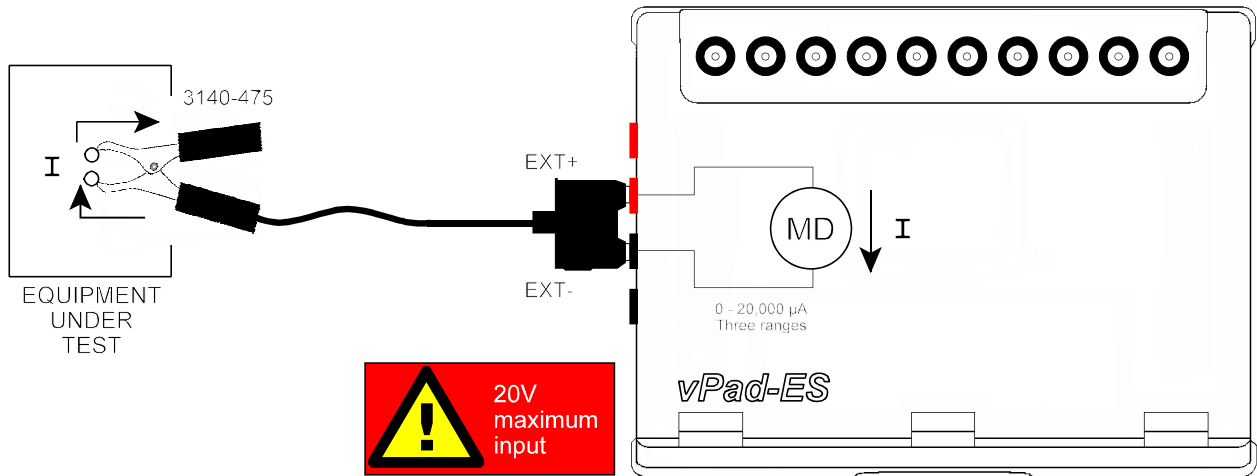

Figure 44 - External leakage test with one Kelvin cable.

4.8.4 Test Application

At a minimum, chassis leakage of medical equipment should be tested with the AC supply in normal polarity and with the ground open, with equipment power switch set to ON position and then to OFF position. In this case, the number of measurements performed will be two. For non-conductive equipment enclosures, apply tin foil onto the enclosure and attach the Kelvin Cable to the foil.

Depending on the electrical safety standard applied in your country or region, ground leakage tests and additional testing conditions may be necessary. vPad-ES encompasses requirements of the standards by providing the necessary test settings that enable you to follow the electrical standard applicable to your region. Required tests and testing conditions for various electrical standards are specified in TABLE 2.3-3 of Section 2.3. Refer to TABLE 2.3-4 of Section 2.3 for maximum limits which apply to each test.

4.9 Patient Lead Tests

Select the Patient Lead test mode by pressing the corresponding tab at the top of the screen. When this mode is selected, the test receptacle is switched **ON** automatically, in normal condition. Refer to Section 4.4 for important information and instructions concerning operation of the test receptacle.

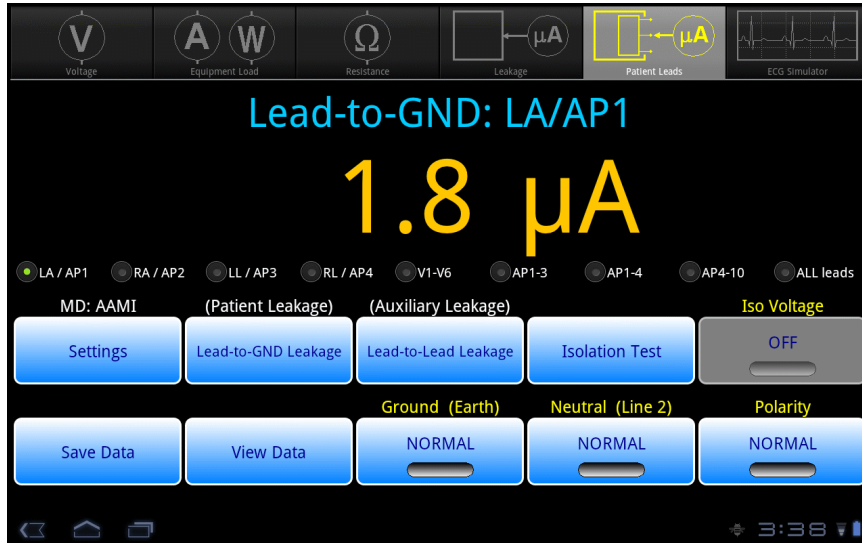

Figure 45 - Patient Lead test mode.

This test mode enables measurement of Lead-to-Ground and Lead-to-Lead Leakage currents (or, in IEC terminology, Patient Leakage and Auxiliary Leakage respectively). Isolation testing of patient leads may also be performed. As selected by the upper row of buttons, the leakage under test is indicated immediately above the numeric readout. Additionally, the patient lead (ECG) or applied part (AP) under test is also indicated. The leakage current is continuously measured and displayed until a different test mode is selected. The bottom row of buttons provide these functions:

- Save Data** Press to save the leakage value currently being displayed. Refer to Section 4.13 for instructions on data recording.
- View Data** Press to review measurement data recorded during testing.
- Ground (Earth)** Press to toggle the ground of the test receptacle between "Normal" and "Open" conditions.
- Neutral (Line 2)** Press to toggle the neutral of the test receptacle between "Normal" and "Open" conditions.
- Polarity** Press to toggle the polarity of the test receptacle between "Normal" and "Reverse" conditions.

vPad-ES OPERATORS MANUAL

Refer to Section 4.8.1 for instructions on operation of the **Ground, Neutral** and **Polarity** test receptacle controls.

Sections 4.9.1 to 4.9.3 provide instructions for the Patient Lead test mode.

4.9.1 Lead-to-Ground Leakage

Press the **Lead-to-GND Leakage** button to measure leakage current from a selected ECG lead or patient-applied part (AP) to ground of the AC supply. For compliance with IEC test requirements, this test mode also permits selection of functional groups of applied parts in various combinations. Lead-to-GND Leakage is the default upon selection of the Patient Lead test mode.

Connect the EUT to the test receptacle, and connect EUT patient leads to the binding posts of vPad-ES, as shown in **Figure 46**.

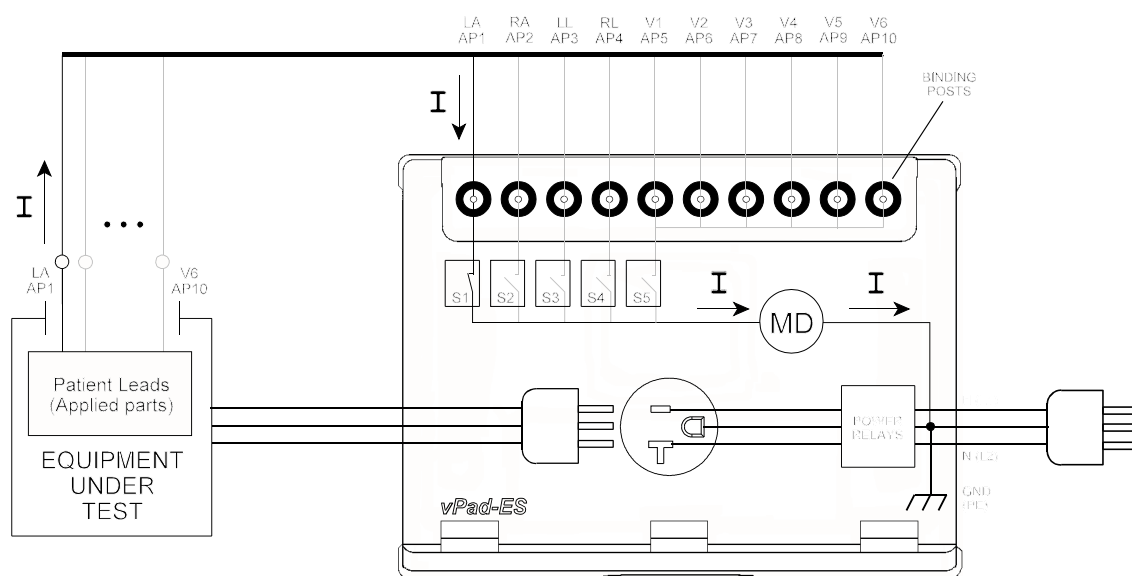

Figure 46 - Lead-to-ground leakage test.

Binding posts of vPad-ES operate according to **Figure 47**: for patient leads terminated in a 3 mm or 4 mm banana plug, press the spring-loaded collar of the binding post down to expose the receptacle inside, insert the plug, then release to secure the plug in place (**Figure 47-(b)**). This method will also work with bare wires. If testing ECG snap leads, press the collar of the binding post down then rotate to lock in place, exposing the male button (**Figure 47-(c)**). ECG snap connectors may then be attached to the buttons. Follow the markings on the vPad-ES label when connecting ECG leads (LA; RA; LL; RL and V1-V6).

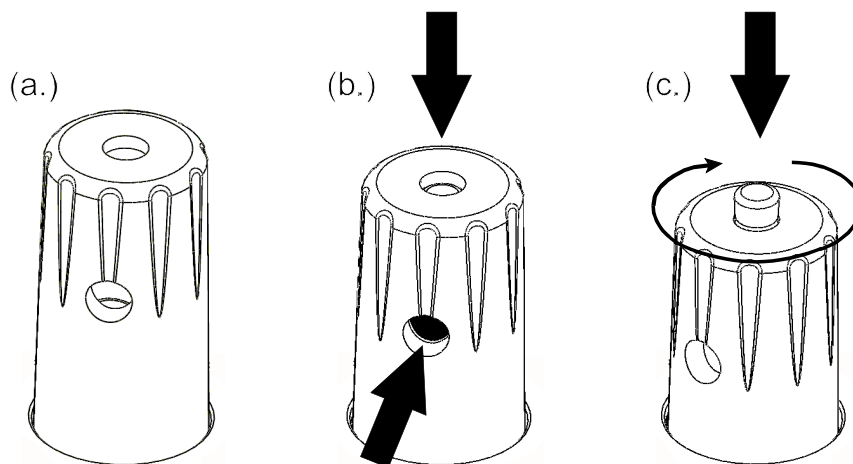

Figure 47 - Operation of binding post.

Referring to **Figure 45**, select patient leads individually or in groups by pressing the corresponding radio button under the numeric readout. This closes the corresponding switch or switches S_1 to S_5 of **Figure 46**, connecting the measuring device (MD) to the lead(s). Leakage current sourced from the lead(s) to ground is measured over three ranges (200, 2000 or 20000 μA full scale), with range being automatically selected by vPad-ES as required.

According to **Figure 46**, terminals V1-V6 (AP6-AP10) are shorted together inside vPad-ES, forming a common lead. In the event that high leakage is observed from the V1-V6 group, disconnect from V1-V6 then reconnect one lead at a time, to determine which of the leads causes or contributes to the problem.

Patient leakage to earth may be tested for IEC Class I and Class II medical equipment. No special provisions are required when testing Class II, however, note the **Ground** control of the safety analyzer will have no influence on the test result since the EUT lacks a ground conductor in the line cord.

4.9.2 Lead-to-Lead Leakage

Press the **Lead-to-Lead Leakage** button to measure leakage current which flows from a selected patient lead or applied part (AP) to all other leads shorted together.

Connect the EUT as previously instructed in Section 4.9.1. Referring to **Figure 48**, select the lead to be tested by pressing the corresponding radio button under the numeric readout. This closes a corresponding switch S_{1a} to S_{5a} of **Figure 49**, connecting the measuring device (MD) from the selected lead to the other leads via S_{1b} to S_{5b} . As described in Section 4.9.1, V1-V6 are shorted together inside vPad-ES and so are treated as a single lead. Leakage current is measured over three ranges (200, 2000 or 20000 μA full scale), with the range being automatically selected by vPad-ES, as required.

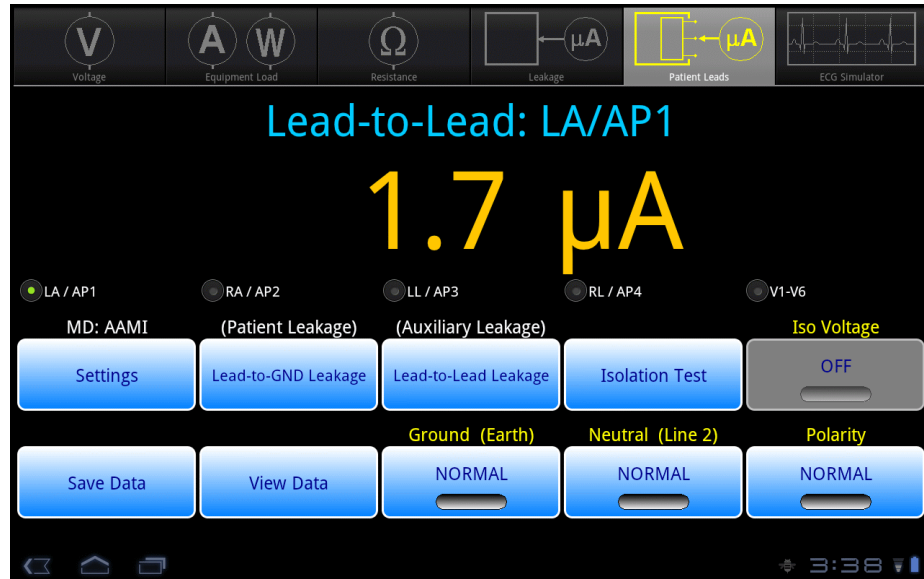

Figure 48 - Lead-to-lead leakage display.

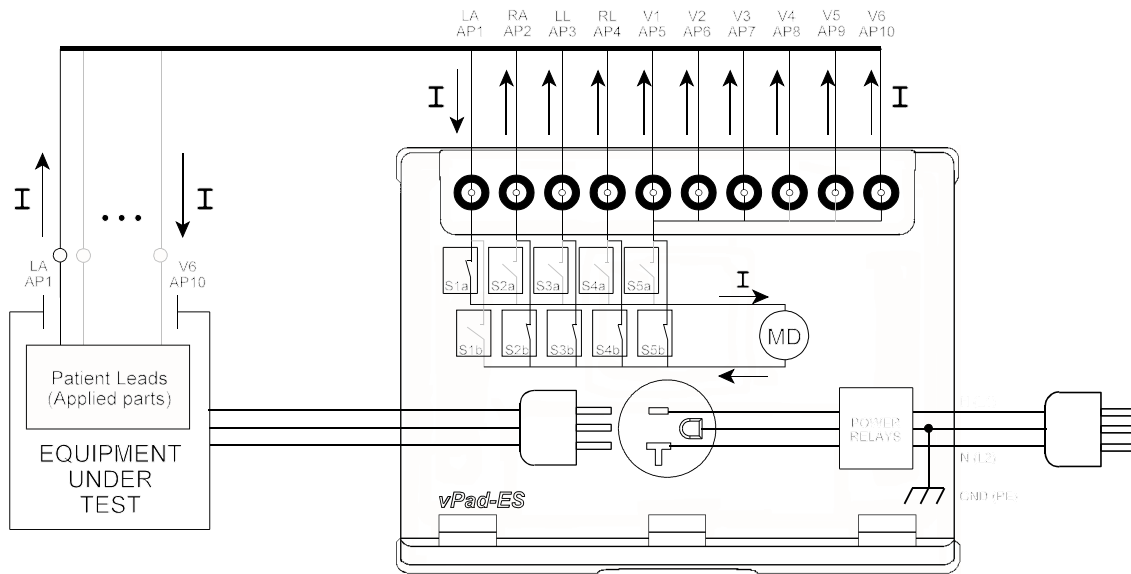



Figure 49 - Lead-to-lead leakage test.

Lead-to-lead (auxiliary) leakage may be tested for IEC Class I and Class II medical equipment. No special provisions are required when testing Class II, however, note the **Ground** control of the safety analyzer will have no influence on the test result since the EUT lacks a ground conductor in the line cord.

4.9.3 Lead Isolation Test



In performing lead isolation tests, a high voltage (maximum 264 VAC) appears at user-accessible terminals of vPad-ES. To protect the operator, high-voltage output is both current- and time-limited.

Careless operation of vPad-ES may result in electric shock when performing lead isolation tests. Read and understand all instructions prior to use.

Press the **Isolation Test** button to measure leakage current which is caused by connecting a selected ECG lead or patient-applied part (AP) to an isolated, current-limited source of voltage equal to the AC supply. For compliance with IEC test requirements, this test mode also permits selection of functional groups of applied parts in various combinations.

Selecting this test enables the **Iso Voltage** button and disables the **Ground** and **Neutral** receptacle controls. This prevents inadvertent selection of double-fault conditions which are not permitted by AAMI and IEC standards. On initial selection of the test, the isolation voltage is OFF and no leakage reading is displayed (*Figure 50*).

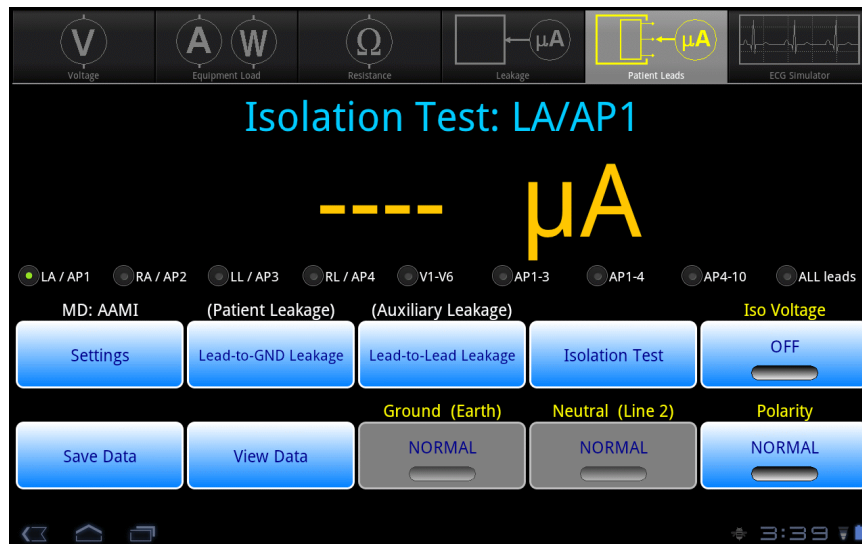

Figure 50 - Lead isolation test (isolation voltage OFF).

vPad-ES OPERATORS MANUAL

To prepare for the test, connect the power cord of the EUT to the test receptacle, and connect the EUT patient leads to the corresponding binding posts of vPad-ES as shown in **Figure 51**. If the EUT is Class II (two-wire power cord), use a jumper lead to connect the green "AUX" test jack on the right side of the Base Unit to the EUT enclosure. See Section 4.9.4 for more information.

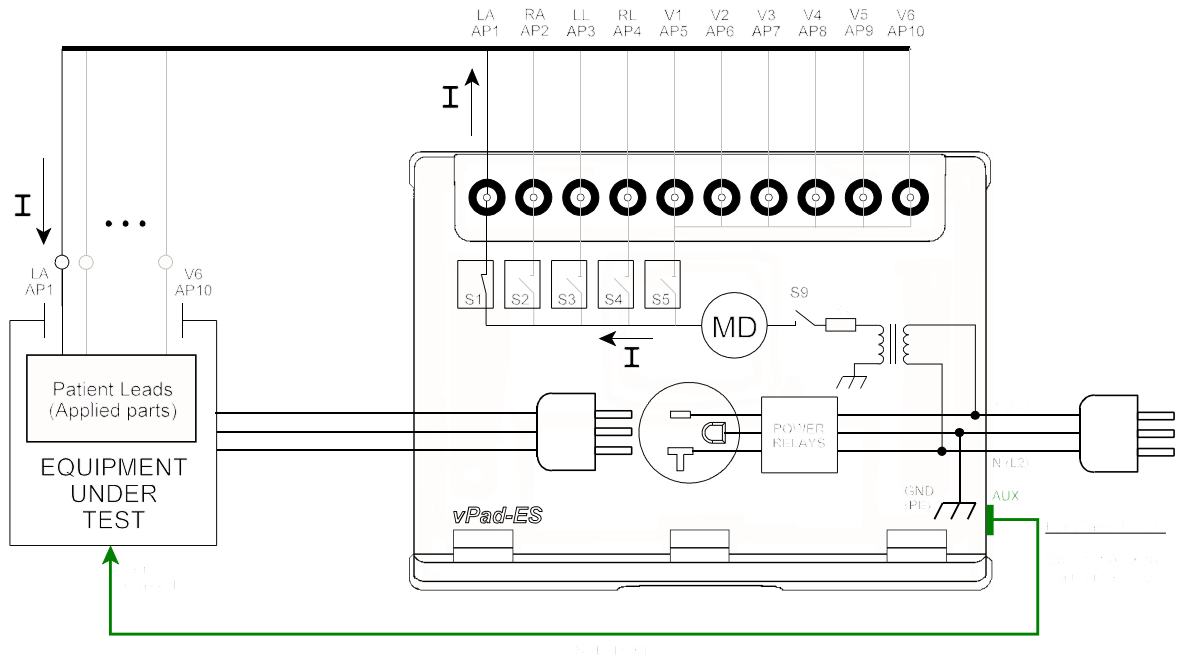

Figure 51 - Lead isolation test diagram.

Referring to the menu of **Figure 50**, select the lead or functional group to be tested with a corresponding radio button, then activate the isolation test voltage by pressing the **Iso Voltage** button. For safety of the operator, the test voltage will remain active for a maximum of **20 seconds**, after which vPad-ES will automatically switch the voltage OFF. The time may be terminated early by pressing ON again. When the test voltage is active, the test description is displayed in **red** and the time remaining until test voltage deactivation is displayed immediately above the **Iso Voltage** button (see **Figure 52**). At any time, the test voltage may be switched OFF by pressing the **Iso Voltage** button.

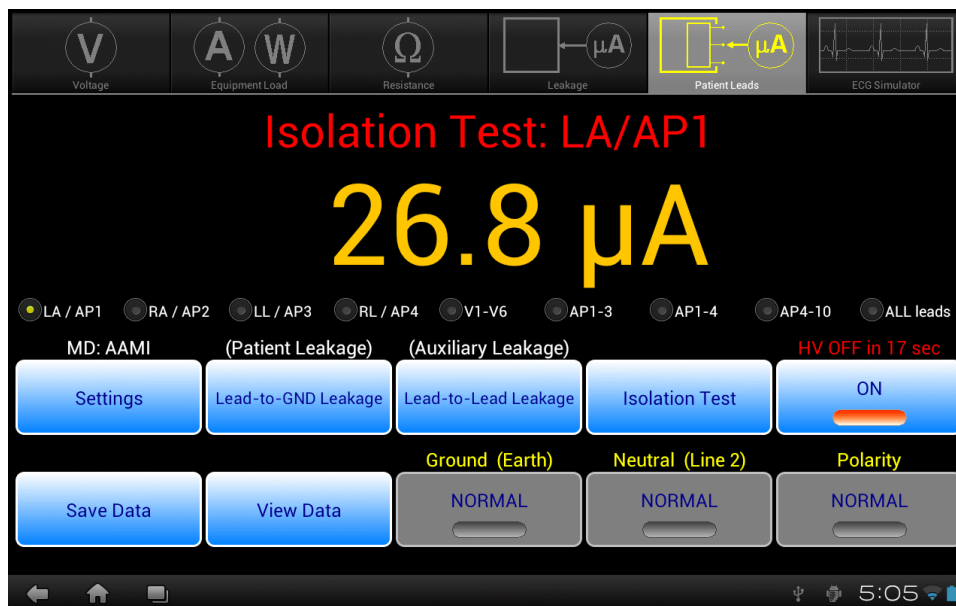

Figure 52 - Lead isolation test (isolation voltage ON).

While the test voltage is either OFF or ON, individual patient leads or lead groups may be selected by pressing the corresponding radio button under the numeric readout. Selecting a particular lead or group of leads closes the corresponding switch or switches S_1 to S_5 of **Figure 51**, connecting the measuring device (MD) between the lead(s) and the isolation transformer. As previously described, V1-V6 (AP6-AP10) are treated as a single lead. When the ISO Test Voltage is ON (S_9 closed), the resulting leakage current is measured over three ranges (200, 2000 or 20000 μA full scale), with the range being automatically selected by vPad-ES, as required.

4.9.4 Test Application

At a minimum, medical equipment with patient leads should be tested for source leakage current to ground. A minimal test will check all patient leads at once, shorted together as a single group. Tests should be done at normal AC supply polarity, with ground normal and with ground open. After performing tests with equipment power switch in ON position, repeat with equipment power switch in the OFF position. In this case, the number of measurements performed will be four. This very basic test will satisfy the essential requirements of the NFPA 99 standard.

More comprehensive tests may be necessary, which will depend on the electrical standard applicable to your region, and the number and type of patient leads the EUT has. Required tests and testing conditions for AAMI-ES1 and IEC 60601 are specified in TABLE 2.3-3 of Section 2.3, with corresponding leakage limits being specified in TABLE 2.3-4.

vPad-ES OPERATORS MANUAL

To summarize testing requirements for AAMI-ES1, leakage to ground is measured for each EUT lead individually as well as for all leads shorted together as a group. Isolation tests are performed on individual leads only. Under this standard, tests do not depend on the medical function of the leads.

A greater number of test requirements are specified under the IEC 60601 standard. Each medical function provided by the EUT is to be tested separately, with all patient leads or connections of the medical function tested as a group. For a functional group having Type CF leads, the leads of the group are tested on an individual basis. For a medical function having Type B or BF leads, the leads are tested while being shorted to each other.

For example, a portable patient monitor may provide three ECG leads (LA; RA; and LL) which are rated for direct cardiac application, and are thus specified by the monitor manufacturer as IEC Type CF. The monitor has two independent temperature channels (T1 and T2), which are specified by the manufacturer as Type BF (electrically isolated, but not for cardiac application). To test this patient monitor, LA, RA and LL are respectively connected to binding posts AP1, 2 and 3 of vPad-ES, and T1 and T2 are respectively connected to AP4 and 5. Lead-to-ground leakage and isolation of each ECG lead is tested individually, via the **LA/AP1**, **RA/AP2** and **LL/AP3** radio buttons on the menus of *Figure 45* and *Figure 50* respectively. Lead-to-ground leakage and isolation of T1 and T2 are tested with the temperature leads shorted together, via the **AP4-10** radio button.

If the equipment is ungrounded and thus has a two-wire power cord, a test jumper lead must be used to connect the enclosure of the equipment to the "AUX" jack of the vPad-ES, as shown in *Figure 51*. If the "AUX" connection is omitted when testing patient leads of ungrounded (Class II) equipment, then no leakage current will be measured.

4.10 Leakage Settings

Press the **Settings** button of the Leakage test mode (*Figure 35*) or the Patient Lead test mode (*Figure 45*) to enter the Leakage Settings menu, shown in *Figure 53*.

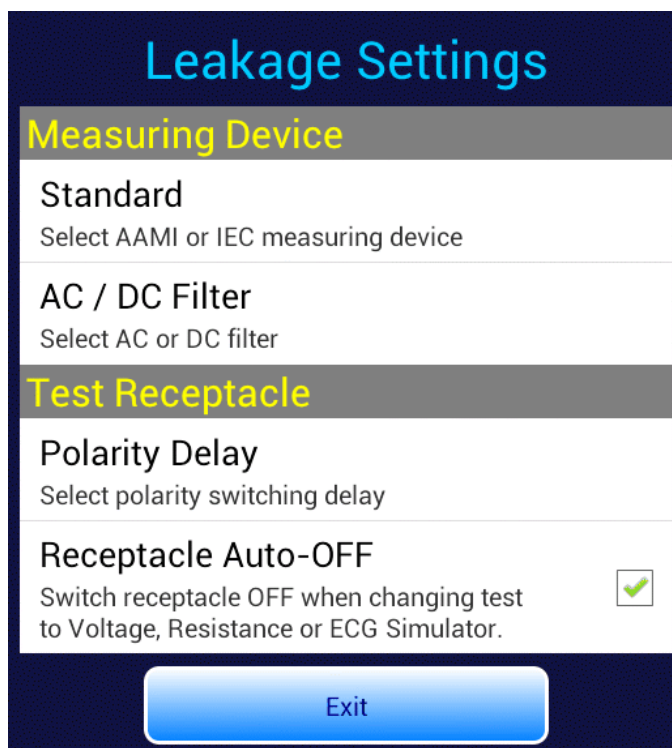

Figure 53 - Leakage settings menu.

At the bottom of the menu, the **Receptacle Auto-OFF** setting determines behaviour of the test receptacle when changing test modes. For convenience, vPad-ES automatically switches the test receptacle ON when Equipment Load, Leakage or Patient Lead test mode is selected. When changing to Voltage, Resistance or Simulator mode, the test receptacle will be automatically switched OFF if **Auto-OFF** is checked, as shown in *Figure 53*. If Auto-OFF is not checked, when changing modes the test receptacle will be switched OFF only if the receptacle is in reverse polarity or single-fault condition, otherwise the receptacle will remain ON as modes are changed.

The default is **Auto-OFF** enabled; disable **Auto-OFF** only for special situations where repeated application and removal of power to the EUT must be avoided.

vPad-ES OPERATORS MANUAL

To view or change a setting other than **Auto-OFF**, press the corresponding row on the menu (**Standard**; **AC/DC Filter**; or **Polarity Delay**).

The **Standard** setting (*Figure 54*) allows you to choose the type of leakage measuring device (MD) based on the Standard to be used. Press the radio button corresponding to the desired MD, or **Cancel** to exit without changing the setting. Note the selected MD is indicated above the **Settings** button on the Leakage or Patient Lead display (*Figure 35* or *Figure 45* respectively). Refer to Section 2.3 for more details on AAMI and IEC measuring devices.

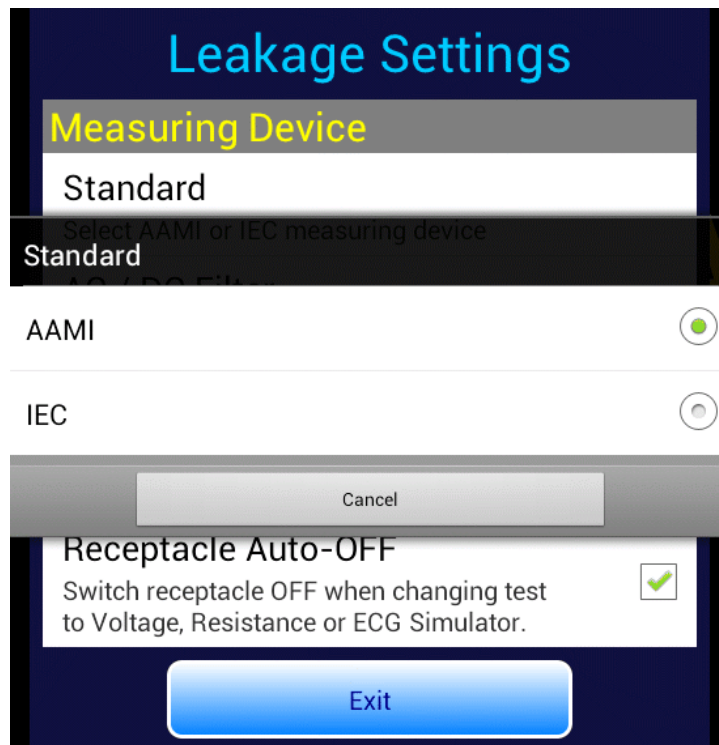

Figure 54 - Set measuring device standard.

The **AC/DC Filter** setting (*Figure 55*) allows you to enable a filter which is connected to the measuring device. The AC-only filter removes DC offset from the leakage current, so that measurements include time-varying components only. Conversely, the DC-only filter suppresses line frequency and higher AC components.

Depending on the filter selected, units of measure will be displayed as either "**µA ac**" or "**µA dc**" accordingly. If no filter is selected, leakage readings are true-RMS values in which case the units of measure are shown as "**µA**"; this is the default setting.

Press the radio button to enable the corresponding filter, or **Cancel** to exit without changing the setting.

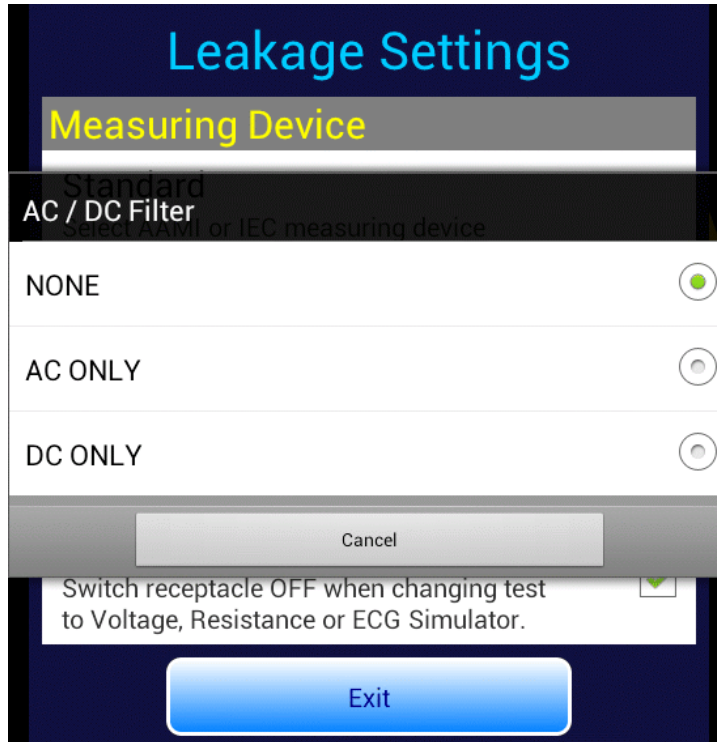

Figure 55 - Set measuring device filter.

When the test receptacle polarity is changed during a test, the receptacle is switched OFF for a period of time, after which the receptacle is then re-activated at the new polarity. This time delay is necessary to prevent surges in supply current which could potentially damage the EUT and/or vPad-ES. A fixed two-second delay is used if the neutral is open when polarity is changed. If the neutral is in normal condition when polarity is changed, a user-selectable delay then applies which may be set over a range of 2 to 8 seconds (see *Figure 56*).

The default delay is 2 seconds. Delays of 2 or 3 seconds may be used with low-powered equipment which will not suffer ill effects from cycling of the AC power. Longer delays of up to 8 seconds should be used for higher-powered equipment, particularly if the equipment presents a reactive load such as an induction motor.

Press the radio button to select the desired delay time, or **Cancel** to exit without changing the setting.

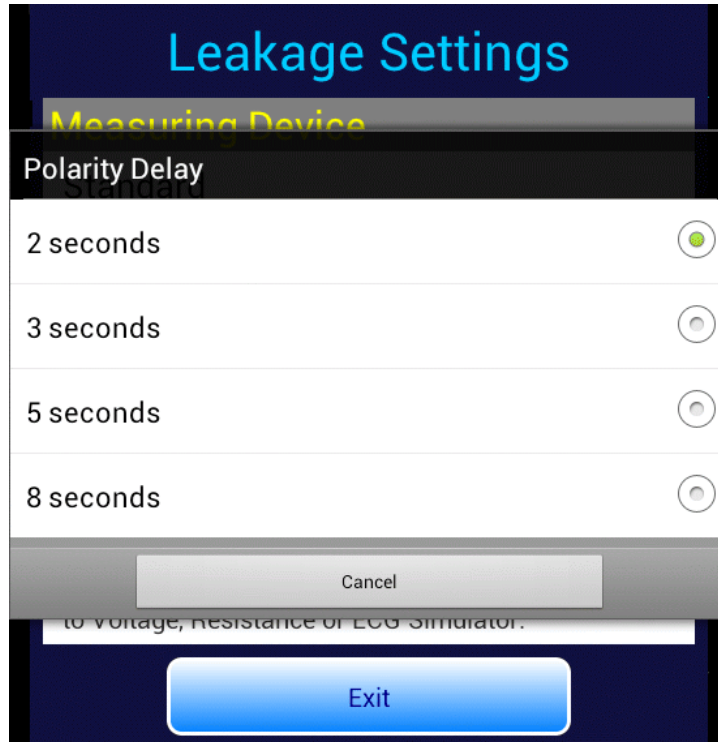

Figure 56 - Set polarity switching delay.

4.11 ECG Simulator

Select ECG Simulator mode by pressing the corresponding tab at the top of the screen. vPad-ES will default to outputting a 2 Hz square wave to the ECG binding posts.

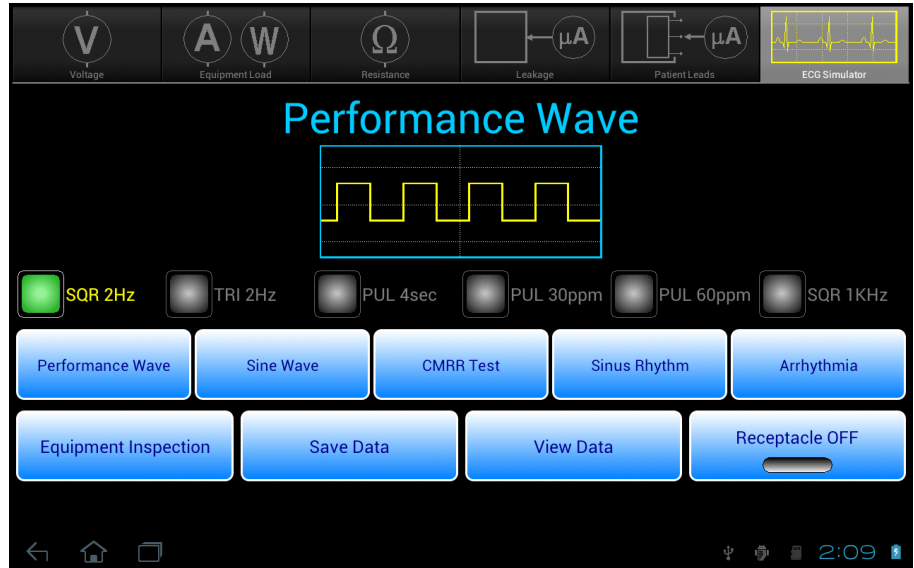

Figure 57 - ECG simulator mode.

Test signals and physiological simulations are organized in five general categories such as Performance Waves or Sinus Rhythm. Under each category, six waveforms may be selected via radio buttons. Upon selecting a waveform, a simplified illustration of the signal is displayed on-screen above the radio buttons. The bottom row of buttons provide these functions:

Equipment Inspection

Press to launch the equipment inspection procedure. See Section 4.12 for instructions.

Save Data

Press to save the name of the ECG waveform in use. In addition to the waveform, test notations may be saved. Refer to Section 4.13 for instructions on data recording.

View Data

Press to review measurement data recorded during testing.

Receptacle ON/OFF

Press to switch the test receptacle ON or OFF as desired. Refer to Section 4.4 for important information and instructions concerning operation of the test receptacle.

vPad-ES OPERATORS MANUAL

TABLE 4.11-1 describes the waveforms which may be selected via the menu. Amplitudes are specified for ECG Lead II connection at the patient monitor.

TABLE 4.11-1: ECG Simulator Waveforms

Simulator Menu	Simulator Waveform Description	vPad-ES Name
Performance	Square wave, 2 Hz, 1 mV p-p (-0.5 to +0.5 mV)	SQR 2Hz
Performance	Triangle wave, 2 Hz, 1 mV p-p (-0.5 to +0.5 mV)	TRI 2Hz
Performance	'DC' Pulse, +1 mV for 4 seconds, 0 mV for 4 seconds	PUL 4sec
Performance	Pulse, +1 mV for 63 msec, rate = 30 pulses/minute	PUL 30ppm
Performance	Pulse, +1 mV for 63 msec, rate = 60 pulses/minute	PUL 60ppm
Performance	Square wave, 1 kHz, 1 mV p-p (-0.5 to +0.5 mV)	SQR 1KHz
Sine wave	Sine wave, 0.5 Hz, 1 mV p-p (-0.5 to +0.5 mV)	SIN 0.5Hz
Sine wave	Sine wave, 10 Hz, 1 mV p-p (-0.5 to +0.5 mV)	SIN 10Hz
Sine wave	Sine wave, 40 Hz, 1 mV p-p (-0.5 to +0.5 mV)	SIN 40Hz
Sine wave	Sine wave, 50 Hz, 1 mV p-p (-0.5 to +0.5 mV)	SIN 50Hz
Sine wave	Sine wave, 60 Hz, 1 mV p-p (-0.5 to +0.5 mV)	SIN 60Hz
Sine wave	Sine wave, 100 Hz, 1 mV p-p (-0.5 to +0.5 mV)	SIN 100Hz
CMRR test	Square wave, 2 Hz, 10 mV common-mode	SQR 2Hz
CMRR test	DC Pulse, 10 mV common-mode	PUL 4sec
CMRR test	Sine wave, 0.5 Hz, 10 mV common-mode	SIN 0.5Hz
CMRR test	Sine wave, 50 Hz, 10 mV common-mode	SIN 50Hz
CMRR test	Sine wave, 60 Hz, 10 mV common-mode	SIN 60Hz
CMRR test	Square wave, 1 kHz, 10 mV common-mode	SQR 1KHz
NSR	ECG normal sinus rhythm, 30 beats/minute, 1 mV QRS	30 BPM
NSR	ECG normal sinus rhythm, 60 beats/minute, 1 mV QRS	60 BPM
NSR	ECG normal sinus rhythm, 120 beats/minute, 1 mV QRS	120 BPM
NSR	ECG normal sinus rhythm, 180 beats/minute, 1 mV QRS	180 BPM
NSR	ECG normal sinus rhythm, 240 beats/minute, 1 mV QRS	240 BPM
NSR	ECG normal sinus rhythm, 300 beats/minute, 1 mV QRS	300 BPM

vPad-ES OPERATORS MANUAL

Simulator Menu	Simulator Waveform Description	vPad-ES Name
Arrhythmia	Arrhythmia, ventricular fibrillation, coarse	VFIB
Arrhythmia	Arrhythmia, atrial fibrillation, coarse	AFIB
Arrhythmia	Arrhythmia, supraventricular tachycardia at 200BPM	SVT
Arrhythmia	Arrhythmia, monomorphic ventricular tachycardia at 190 BPM	VTACH
Arrhythmia	Arrhythmia, unifocal preventricular contraction following 5 normal ECG beats	PVC
Arrhythmia	Arrhythmia, asystole, random baseline	ASYS

4.11.1 ECG Test

To test a patient monitor, connect ECG leads to the binding posts of vPad-ES as shown in *Figure 58*. Specific instructions for connecting patient leads to binding posts are given in Section 4.8.1. Optionally, the EUT may be connected to the test receptacle and powered from there. According to *Figure 58*, the ECG simulator outputs three independent signals for the limbs (LA, RA, LL) and a fourth signal which is common to all chest leads (V1-V6). RL provides the zero reference for the circuit which, as indicated, is isolated with respect to the ground of the AC supply.

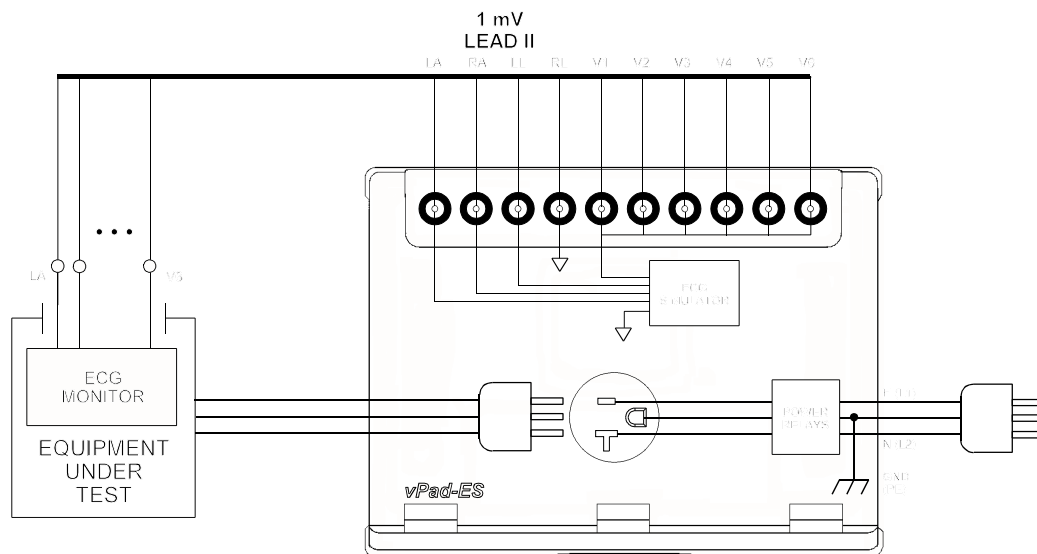

Figure 58 - Connection to ECG simulator.

4.11.2 Common-Mode Test

When a Common-Mode Rejection Ratio (CMRR) test is selected, the ECG simulator is internally configured as shown in **Figure 59**. Limb and chest leads are connected together and driven with a common 10 mV signal with respect to RL.

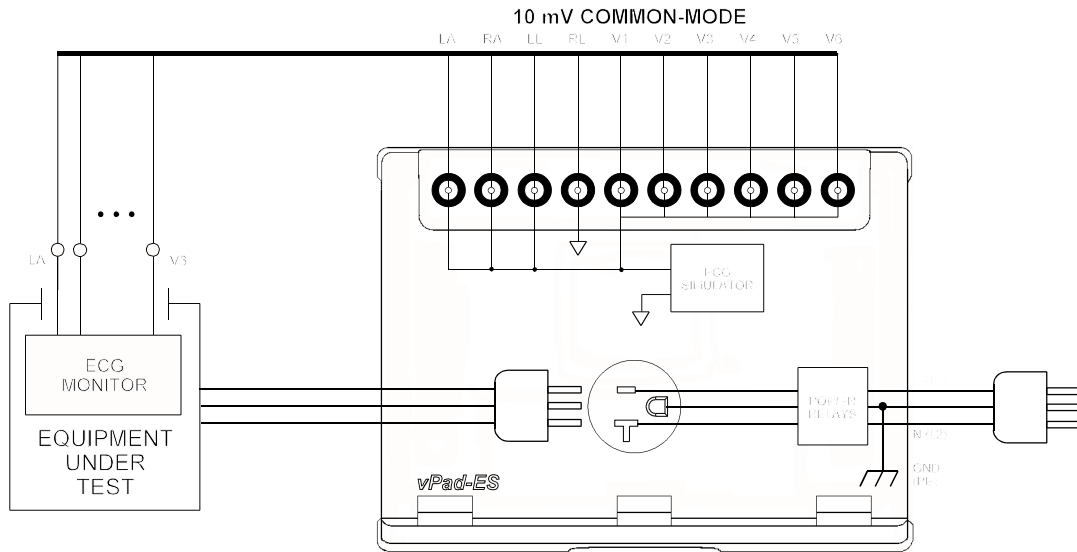

Figure 59 - Common-mode rejection test.

Provided differential amplifiers in the patient monitor are operating correctly, the common-mode signal should be cancelled and there should be no indication on the monitor display for Lead I, II or III. Different waveforms are provided for the CMRR test, allowing common-mode performance to be verified for a range of frequencies and waveshapes.

4.12 Equipment Inspection

4.12.1 Inspection Tasks

Voltage, Load Current, Resistance and ECG Simulator test modes provide an **Equipment Inspection** button. Pressing this button displays a dialog for performing and recording an inspection.

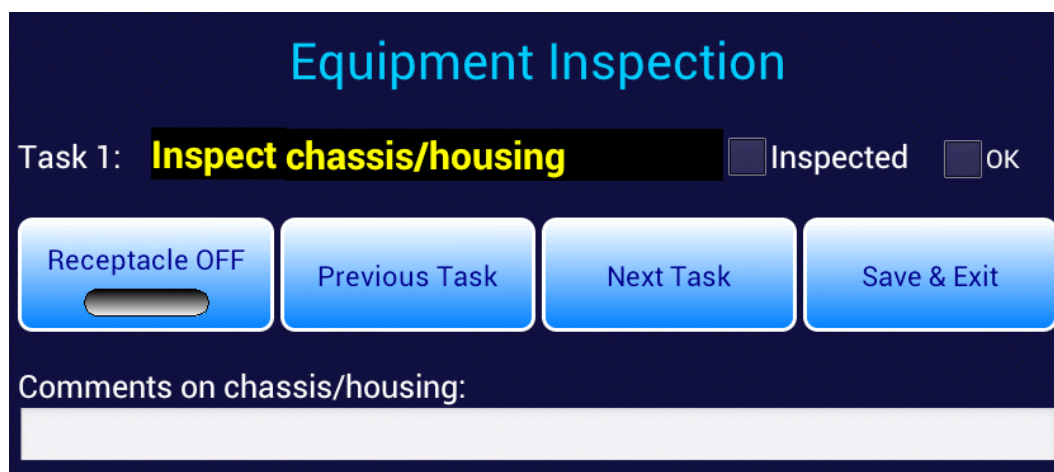

Figure 60 - Equipment Inspection dialog.

The Equipment Inspection is based on a list of checkpoints or tasks, which are explained in the *General Devices Acceptance Procedure* (no. 438-20081015-01), published by the ECRI Institute (USA). This guidance document is in the public domain and may be downloaded from this URL:

https://www.ecri.org/Documents/General_Devices_USA_Acceptance.pdf

The IEC version of the procedure may be obtained from this URL:

https://www.ecri.org/Documents/General_Devices_IEC_Acceptance.pdf

The *General Devices Acceptance Procedure* was developed by ECRI to be generically applicable to medical equipment undergoing incoming inspection, installation or repair service. The procedure includes a number of qualitative checks and maintenance steps which are routinely performed on a wide range of medical devices. Specific electrical safety tests are also described in the ECRI document.

The **Next Task** button on the dialog of *Figure 60* increments the displayed "Task" through a list of items to be inspected or serviced, following the ECRI procedure as summarized in TABLE 4.12-1.

TABLE 4.12-1: Equipment Inspection Tasks

Task	Inspection Activity (perform as applicable)	Summary
1	Chassis/housing	Check for shipping damage; cleanliness; general physical condition.
2	Mounting/fasteners	Check stability (unit won't tip); check security of wall-mount equipment.
3	Casters/brakes	Check casters are correct size; check casters roll freely; check brakes. Repair/replace as necessary.
4	Plug/receptacle(s)	Check plug for damage; ensure blades or blade screws are not loose. Replace if necessary.
5	Power cord	Ensure power cord is long enough; for detachable cord, check for capture device/cleat; check for wear; replace if necessary.
6	Strain reliefs	Verify strain reliefs hold power cord securely and are not damaged; check both ends.
7	Circuit breaker/fuses	Check correct fuses are installed, per equipment labelling or instructions.
8	Tubes and hoses	Check condition; repair/replace as necessary.
9	Cables	Check condition; check continuity while twisting; repair/replace as necessary.
10	Fittings/connectors	Check fittings are correct type; check labelling is correct; check for leaks; check for wear/damage; repair/replace as necessary.
11	Electrodes/transducers	Check required electrodes/transducers are with the equipment; check condition of reusable transducers.
12	Filters	Check condition; clean or replace as required.
13	Controls and switches	Verify software setup parameters accessible through hidden or service menus are correctly set; check physical condition, secure mounting and range of motion for mechanical controls/switches.
14	Heater	Examine for damage; verify heater controls function correctly.

vPad-ES OPERATORS MANUAL

Task	Inspection Activity (perform as applicable)	Summary
15	Motor/pump/fan	Check shaft alignment; check wear; lubricate as required.
16	Fluid levels	Check and fill as required.
17	Battery/charger	Replace battery if necessary or per schedule; check rechargeable battery can hold sufficient charge; check battery charger function.
18	Indicators/displays	During inspection activities, check operation of all lights, indicators, meters, gauges, waveform displays and numeric display segments. Repair/replace as required.
19	Cal/self-test function	Check calibration due label; check self-calibration function; activate self-test or service-mode functions for basic performance verifications.
20	Time/date settings	Check settings are correct.
21	Network setup/security	Document device, operating system, version, IP address; verify passwords and virus protection; verify data backup processes.
22	Alarms and interlocks	Verify alarm settings; induce alarm condition(s) and verify alarm function.
23	Audible signals	During inspection activities, check audio tones/alarms; check volume control function.
24	Labelling	Check required placards, labels, charts and instruction cards are present, legible and easy to understand.
25	Accessories	Verify required accessories are with the equipment.



4.12.2 Performing an Inspection

To use the Equipment Inspection dialog of *Figure 60*:

- a.) Select the task to be performed, using the **Next** / **Previous Task** buttons. Per the ECRI document, tasks can be performed in any order; some tasks may not be applicable to the equipment and would therefore be skipped.
- b.) Perform the inspection task, following the specific instructions of the ECRI document. If necessary, connect the EUT to the test receptacle and apply AC power via the **Receptacle ON / OFF** button on the dialog.
- c.) On completion of the task, press the **Inspected** checkbox. Checking this box adds the inspected item to the Test Record, combining it with safety test measurement data which may be recorded either before or after the inspection (refer to Section 4.13 for full details on saving test results and vPad-ES Test Records). Inspection Tasks which do not have the **Inspected** box checked will not appear in the Test Record.
- d.) If the inspected item meets requirements, press the **OK** checkbox. This assigns a "**PASS**" to the inspected item in the Test Record.
- e.) If an inspected item is not acceptable, and you are not able to correct the problem, do not press the **OK** checkbox. In this case, a "**FAIL**" will be assigned to the inspected item in the Test Record.
- f.) While inspecting, you may wish to record comments about what you find, and any repairs or modifications you may have made to the EUT. To do so, press the **Comments on...** text field, located below the buttons. This will display the Android onscreen keyboard (*Figure 61*). Although the text field is displayed as a single line, you may enter as many characters or sentences as you wish. Comment data entry is reformatted as paragraphs later, when the Test Record is saved.

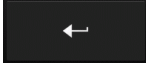

Figure 61 - Inspection comment entry.

- g.) Other inspection items may be selected via **Next / Previous Task** buttons while the Android keyboard is being displayed. Alternatively, once a comment has been input the keyboard can be dismissed, by pressing the ENTER button , or alternatively the "dismiss keyboard" button  at bottom left on the screen. More information on using the Android keyboard is given in Section 4.13.1.

- h.) Once all pertinent items have been inspected, press **Save & Exit** to return to the previous test mode. The Equipment Inspection dialog can be re-opened anytime prior to saving the Test Record, allowing you to view, modify or add inspection results, as needed.

4.13 Data Recording

Each test mode of vPad-ES provides means for recording and viewing measurement data during the course of a test. Once sufficient data has been collected and information about the equipment under test (EUT) has been entered, results may then be saved as a file in a designated folder on the "internal SD card" (internal non-volatile memory) of the Android tablet.

This section provides instructions for recording measurements and notes during a test, and creating Test Records.

4.13.1 Using the Android Keyboard

When you press a text field, the Android keyboard is displayed at the bottom of the screen.



Figure 62 - Android onscreen keyboard (default IME).

Android permits use of various input methods, called "**IME**". The onscreen keyboard is the default IME. If you have connected an alternative input device to the tablet (e.g. Bluetooth/USB keyboard or barcode scanner), then the Android keyboard will not appear when a text field is pressed and data entry will then be from the external input device. To switch back to the default IME, disconnect the external input device.

The text field which is currently accepting data from the Android keyboard or other IME will be highlighted:

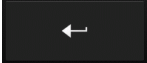





Figure 63 - Single-line text field.

vPad-ES OPERATORS MANUAL

Android text fields may be either single- or multi-line. A practically unlimited amount of text may be typed for either single- or multi-line fields.

Pressing ENTER  for a single-line text field causes data entry to jump to the next text field on the screen.

Pressing ENTER  on a multi-line text field inserts a new line. To move from a multi-line field to a different text field on the screen, tap on the desired field.

Press  to navigate forward through multiple text fields on a screen. Press   to navigate backward. You can also jump to a particular field on a screen simply by tapping the field.

Switch the Android keyboard from alpha to numeric modes by pressing  .

In alpha mode, to activate Caps Lock press and hold  until the indicator lights up: 

Once activated, press  to switch Caps Lock off.

To correct a mistake in typing, tap the text field to the right of the error. This will activate the Android edit cursor. Erase with backspace/correct  then retype.

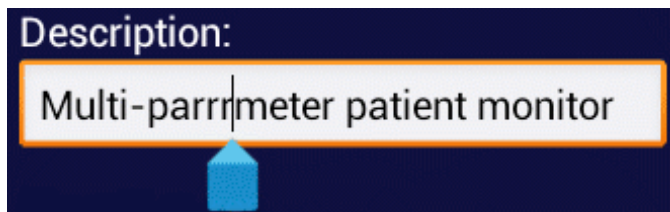



Figure 64 - Error correction with edit cursor.

As an alternative to typing with the keyboard, voice recognition may be used (requires an Internet connection). To enable, press . Android voice recognition technology has good performance, particularly when entering numbers.

When done entering text, the Android keyboard may be removed from the screen by pressing  at bottom left.

4.13.2 Recording Measurements and Notes

While safety testing, press the **Save Data** button to capture the reading currently being displayed on the screen. The captured reading is combined with a description of the measurement and is forwarded to the Save Data menu, which appears as pop-up over the test activity. The measurement with optional notes may then be saved to a temporary holding buffer, located in (volatile) memory.

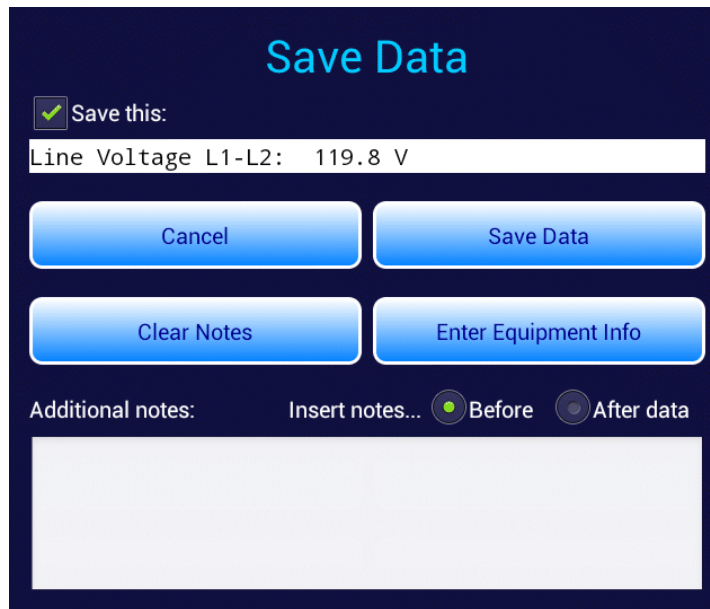

Figure 65 - Save Data pop-up menu.

Tap on the **Additional notes** text field to enter notations or comments, which will then be attached to the measurement being saved. Tapping the text field causes the Android keyboard to be displayed (*Figure 66*). If an external keyboard or barcode scanner is connected to the tablet, the Android keyboard is not displayed and data entry is then accepted from the external input device. Refer to Section 4.13.1 for detailed instructions on using the Android keyboard.



Figure 66 - Enter additional notes or comments.

By default, notes are inserted into the test data *before* the measurement value. Alternatively, to place notations after the measurement value, press the **Insert note... After** radio button (see *Figure 65*).

To save notations only, without any measurement data, uncheck the **Save this** checkbox near the top of *Figure 65*.

Other buttons on the menu of *Figure 65* provide these functions:

- Save Data** Press to add the measurement data and notations (if any) to the holding buffer, then return to the test activity. This button can be pressed anytime to save and exit the menu, even while the keyboard is being displayed.
- Cancel** Press to return to the test activity without saving.
- Clear Notes** Press to erase the **Additional notes** test field.
- Enter Equipment Info** Press to display the equipment information editor (see Section 4.13.4 for instructions on using the editor).

4.13.3 Viewing Measurements and Notes

Via the Save Data menu of Section 4.13.2, measurements and notes may be saved to a holding buffer while testing is in progress. To view contents of this buffer, press the **View Data** button. If the amount of data exceeds the length of the window, scroll it into view by means of a press-and-drag gesture in the window.



Figure 67 - View Data menu.

Buttons on the View Data menu provide these functions:

- Enter Equipment Info*** Press to display the equipment information editor (see Section 4.13.4 for instructions on using the editor).
- Clear Last*** Press to erase the last line of text saved to the holding buffer.
- Clear All*** Press to erase all data currently stored in the holding buffer. An Alert Dialog will be displayed which will prompt you to confirm the erasure.
- Create Record*** Press to save recorded measurement values, notes, equipment information and inspection results as a Test Record file on the Android tablet. This button remains disabled until an Equipment Control Number has been input. See Sections 4.13.4 and 4.13.5 for instructions.
- Exit*** Press to close the View Data menu and return to the test activity.

4.13.4 Recording Equipment Information

Press **Enter Equipment Info** on the Save Data or View Data menu to pop-up the equipment information editor.

The form is titled "Equipment Information" in blue text at the top. It contains two columns of text input fields. The left column includes: "Control Number:" (empty), "Description:" (empty), "Manufacturer:" (empty), "Model:" (empty), "Clear Control+Serial No." (blue button), and "Cancel" (blue button). The right column includes: "Serial Number:" (empty), "Location:" (empty), "Facility:" (empty), "Technician ID:" (empty), "Clear All" (blue button), and "Save Info" (blue button).

Figure 68 - Equipment information editor.

Tap on a text field to display the Android keyboard and enter information. If an external keyboard or barcode scanner is connected to the tablet, the Android keyboard is not displayed and data entry is then accepted from the external input device. Refer to Section 4.13.1 for detailed instructions on using the Android keyboard.



Figure 69



Figure 70

vPad-ES OPERATORS MANUAL

Pressing ENTER  on the keyboard advances data input to the next text field on the screen.

Alternatively, use  to navigate the text fields, or simply tap a field to jump immediately there.

At a minimum an equipment control number, or other ID, must be entered in the **Control Number** field in order to save a Test Record.

"**Facility**" and "**Technician ID**" fields are backed up in permanent storage on the Android tablet. These information fields are maintained after power to vPad-ES is switched off, and are restored on subsequent use of the app.

When done entering information, press  to dismiss the keyboard and expose the following buttons at the bottom of the menu:

- Clear Control+Serial No.*** Press to erase **Control Number** and **Serial Number** fields.
- Clear All*** Press to erase all text fields on the menu.
- Cancel*** Press to return to Save or View Data menu without saving changes.
- Save Info*** Press to save information as displayed, and then return to Save or View Data menu.

4.13.5 Creating a Test Record

Press the **Create Record** button on the View Data menu to save recorded measurement values, notes, equipment information and inspection results as a Test Record file. You must save at least one measurement and an equipment control number/ID before the View Data menu will permit you to create a Test Record (see Sections 4.13.2 through 4.13.4 respectively).

Create Test Record

File name: CN1234_20121214_162651_P.txt

Save to: /mnt/sdcard/Datrend/vPad-ES/Records

Overall test result:

PASS FAIL

Technician labor time: hours

Test report title:

Final comments:

Figure 71 - Create Record menu.

vPad-ES OPERATORS MANUAL

The filename and path of the Test Record are shown at the top of the Create Record menu (*Figure 71*). The filename is derived automatically by vPad-ES, in the following format:

```
<control_number>_<date_code>_<timestamp>_<result>.txt
```

where:

control_number is the **Control Number** field from the Equipment Information menu (see Section 4.13.4).

date_code represents the date of the Record, format YYYYmmDD (year-month-day)

timestamp represents the time of the Record, format hhMMss (hours-minutes-seconds)

result represents the overall result of the test: pass (P) or fail (F)

Test Record files are saved in TXT format, with character encoding that is compatible with both Android (Linux) and Microsoft Windows® operating systems.

Test Records are saved to this location in the Android file system:

```
/mnt/sdcard/Datrend/vPad-ES/Records
```



Note: **sdcard** refers to *internal memory* of the Android tablet.

sdcard is NOT a removable "SD Card" memory device, which may be optionally plugged into the external card slot of the tablet.

Any accessory SD Card which may be plugged into the tablet's card slot is referred to as **extsd** in the Android file system.

The **Overall test result** shown in *Figure 71* will be set to **PASS**, unless a failing result was recorded during an Equipment Inspection (see Section 4.12). Select either **PASS** or **FAIL** radio button to reflect the result you wish to store in the Test Record file.

vPad-ES OPERATORS MANUAL

Optionally, time spent working on the EUT may be entered after tapping on the **Technician labor time** field. This causes the Android numeric keypad to be displayed. Enter the labor time in hours.

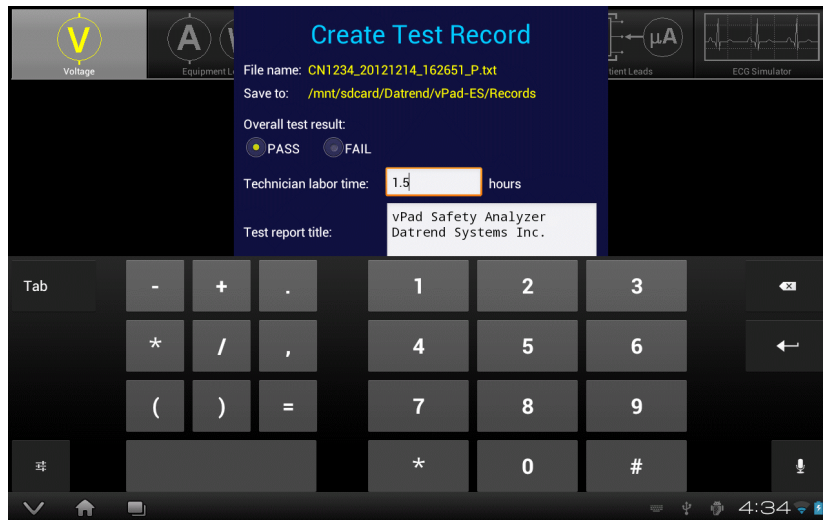

Figure 72 - Optionally, enter technician labor time (hours).

Test Record files include a Title at the beginning of the file. This may be modified from default "**vPad Safety Analyzer**" after tapping the **Test report title** field. Optionally, enter the name of your institution or business, address, phone number and so on. Up to 16 lines may be entered into this text field, of which the first three lines will be shown when the menu is initially displayed (to view or edit additional lines, scroll the window using a press-and-drag gesture). The **Test report title** is backed up in permanent storage on the Android tablet; the title is maintained after power to vPad-ES is switched off, and is then restored on subsequent use of the app.

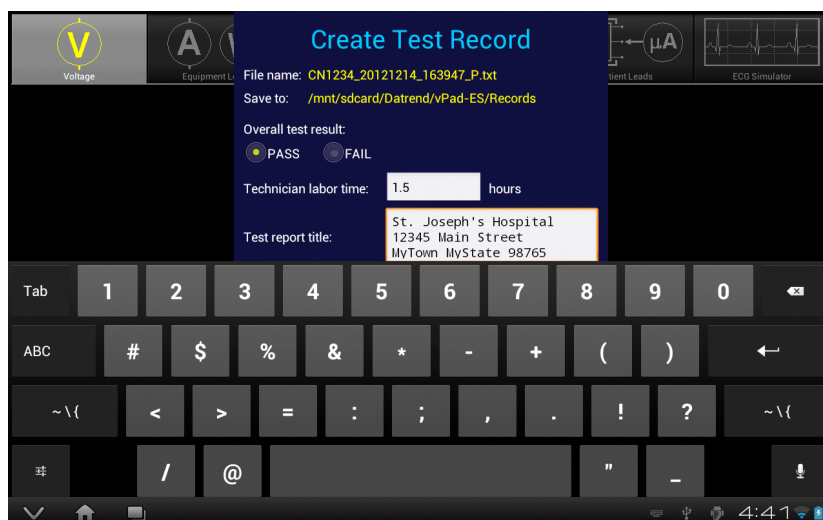

Figure 73 - Optionally, enter report title.

vPad-ES OPERATORS MANUAL

Optionally, concluding comments about the EUT or test results may be entered after tapping the **Final comments** field. Information entered in this text field will appear at the end of the Test Record file. Any number of lines may be entered into the text field.

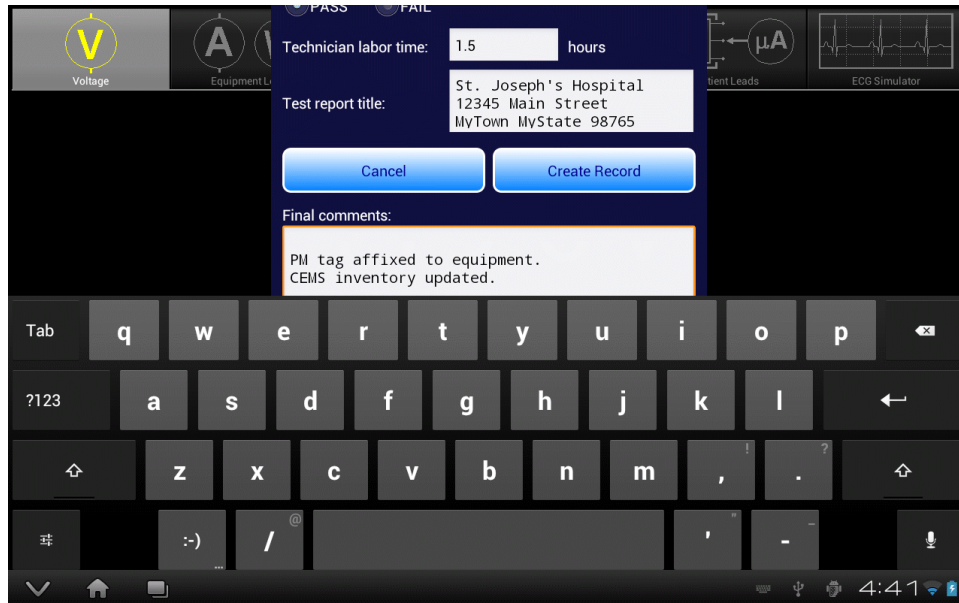

Figure 74 - Optionally, enter final comments about EUT or test.

Press the **Create Record** button at any time to save the Test Record file, whether or not the Android keyboard is active. Alternatively, press **Cancel** to exit the menu without saving a file. On cancelling, measurements and other data stored in the temporary holding buffer are retained.

When **Create Record** is pressed:

- The Test Record file is saved to `/mnt/sdcard/Datrend/vPad-ES/Records` in the tablet;
- The temporary holding buffer is erased, clearing all recorded measurement values, notes, and equipment inspection results;
- **Control Number** and **Serial Number** fields of the Equipment Information are erased;
- Other fields of the Equipment Information (**Description**, **Manufacturer**, **Model** and so on) are *not* erased. This is intended as a time-saving feature when performing acceptance tests and inspections on multiple EUT of the same type.

An example of a Test Record file saved by vPad-ES is given in APPENDIX A.

4.14 Record Manager App

vPad Record Manager is an app which is installed on the Android tablet and which may be run independently of, or simultaneously with, the vPad-ES app.

Record Manager may be used to copy, print, and/or delete Test Record files saved by vPad-ES. Record Manager can also be used to convert Test Records to Adobe PDF documents. Note that PDF is a format which enables vPad Record compatibility with other Android apps, for example, e-book readers and document printing apps.

Press  on the Android HOME screen to launch the Record Manager app.



Figure 75 - File browser of vPad Record Manager.

Refer to **MN-087a 6100-081 vPad-RM Operators Manual** for further information on use of the Record Manager.

5 Calibration and Maintenance

Calibration of vPad-ES by a Datrend Authorized Service facility is recommended on an **annual** basis, and is **required** to extend the product warranty. The basic one (1) year warranty on the Analyzer Base Unit can be extended to a maximum of two (2) years provided that annual calibration is performed by a Datrend Authorized Service Center on an **annual** basis. Refer to the Calibration Decal applied to the rear panel of the unit to determine calibration status of your vPad-ES.

vPad-ES contains no user serviceable parts, other than a 20 Amp/250V AGC fuse located on the right side panel of the Analyzer Base Unit. Any other failure will require return of vPad-ES to an authorized service facility for repair. **Opening the case of vPad-ES for any reason will void the warranty and may compromise user safety.**



Service must be performed by a factory trained, authorized service agent. This unit contains hazardous voltages which may cause injury if correct service procedures are not followed.

For calibration or service assistance, contact Datrend for a Return Materials Authorization (RMA) number and the location of the nearest Service Facility.

Datrend Systems Inc.
Unit 130 - 4020 Viking Way
Richmond, BC • CANADA • V6V 2L4
Tel 604.291.7747 or 800.667.6557 • Fax 604.294.2355
e-mail customerservice@datrend.com
www.datrend.com

vPad-ES may be cleaned with a soft, lint free, damp cloth using a mild detergent. Use of other cleaning agents on the touchscreen may result in scratching, discolouration, streaking or even failure.



Electrical safety protection of the operator may be compromised if the instructions in this manual are not followed, or if vPad-ES is used for a purpose not specified in this manual.

vPad-ES OPERATORS MANUAL

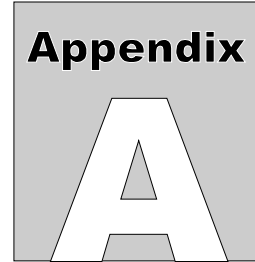

APPENDIX A. Sample Test Record

This appendix provides an example of a vPad-ES Test Record, illustrating the data representation for voltage, current, resistance and leakage measurements, as well as ECG waveform data. Inspection data and example notes have been recorded for some measurements to show how these typically appear in a record. This is an example of a "maximum" file where all possible measurements and inspections have been recorded.

Biomedical Engineering Dept.
St. Joseph's Hospital
1234 Main Street
MyTown MyState 98765
Phone: 123-456-7890 Ext. 123

File: CN123456_20120618_173835.txt
Date: 2012 Jun 18
Time: 17:38:35
vPad-ES: VPES12010001

Equipment Information...
Control Number: CN123456
Description: Diagnostic ECG
Manufacturer: Marquette
Model: MAC VIEW
Serial Number: 4459-712-50-DE
Location: CCU
Facility: St Josephs Hosp

Technician ID: MEM
Tech Time (hrs): 0.5

Overall Result: PASS

Signature: _____ Date: _____

Equipment Inspection...
Chassis/housing: PASS
Small dent at the rear of the unit.
Acceptable.
Mounting/fasteners: PASS
Casters/brakes: PASS
Plug/receptacle(s): PASS
Power cord: PASS

vPad-ES OPERATORS MANUAL

Line cord insulation was split. Replaced the cord.

Strain reliefs:	PASS
Circuit breaker/fuses:	PASS
Wrong fuse was installed. Replaced with correct fuse.	
Tubes and hoses:	PASS
Cables:	PASS
Fittings/connectors:	PASS
Electrodes/transducers:	PASS
Filters:	PASS
Controls and switches:	PASS
Heater:	PASS
Motor/pump/fan:	PASS
Fluid levels:	PASS
Battery/charger:	PASS
Replaced clock backup battery.	
Indicators/displays:	PASS
Cal/self-test function:	PASS
Time/date settings:	PASS
Network setup/security:	PASS
Alarms and interlocks:	PASS
Audible signals:	PASS
Labelling:	PASS
Accessories:	PASS

Detailed Test Data...

Safety Standard: AAMI

This test begins with some voltage measurements although any test data may come first in a file. This paragraph is an example of "additional notes". By default, notes are inserted BEFORE measurement data.

Line Voltage L1-L2: 119.8 V
Line Voltage L1-GND: 121.1 V
Line Voltage L2-GND: 2.5 V
External Voltage: 3.2 V

The notes text box can also be used to insert a blank line, as was done immediately prior to this note.

Load Current: 10.49 A
Equipment Power: 1256 W

Line Cord Resistance: 0.093 ohm
Another note is inserted here, prior to making the External Resistance measurements. This note could be used to explain what points on the EUT chassis were probed to make these measurements.

External Resistance:	0.184 ohm
External Resistance:	0.198 ohm
External Resistance:	0.251 ohm
External Resistance:	0.267 ohm
External Resistance:	0.259 ohm

A full leakage test, using all possible test conditions...

Chassis Leakage (POL-N;NEU-N;GND-N):	1.3 μ A
Chassis Leakage (POL-N;NEU-N;GND-O):	186.7 μ A

vPad-ES OPERATORS MANUAL

Chassis Leakage	(POL-N;NEU-O;GND-N) :	12.6	µA
Chassis Leakage	(POL-R;NEU-N;GND-N) :	3.8	µA
Chassis Leakage	(POL-R;NEU-N;GND-O) :	189.1	µA
Chassis Leakage	(POL-R;NEU-O;GND-N) :	15.1	µA
Ground Leakage	(POL-N;NEU-N;GND-O) :	186.7	µA
Ground Leakage	(POL-N;NEU-O;GND-O) :	197.8	µA
Ground Leakage	(POL-R;NEU-N;GND-O) :	189.1	µA
Ground Leakage	(POL-R;NEU-O;GND-O) :	200.4	µA
Extrnal Leakage	(POL-N;NEU-N;GND-N) :	2.8	µA
Extrnal Leakage	(POL-N;NEU-N;GND-O) :	2.9	µA
Extrnal Leakage	(POL-N;NEU-O;GND-N) :	2.8	µA
Extrnal Leakage	(POL-R;NEU-N;GND-N) :	5.3	µA
Extrnal Leakage	(POL-R;NEU-N;GND-O) :	5.4	µA
Extrnal Leakage	(POL-R;NEU-O;GND-N) :	5.4	µA

Lead leakages, all possible combinations of leads and test conditions...

Lead-GND LA/AP1	(POL-N;NEU-N;GND-N) :	1.8	µA
Lead-GND RA/AP2	(POL-N;NEU-N;GND-N) :	1.8	µA
Lead-GND LL/AP3	(POL-N;NEU-N;GND-N) :	1.7	µA
Lead-GND RL/AP4	(POL-N;NEU-N;GND-N) :	1.7	µA
Lead-GND V1-V6	(POL-N;NEU-N;GND-N) :	1.7	µA
Lead-GND AP1-3	(POL-N;NEU-N;GND-N) :	3.2	µA
Lead-GND AP1-4	(POL-N;NEU-N;GND-N) :	3.3	µA
Lead-GND AP4-10	(POL-N;NEU-N;GND-N) :	3.3	µA
Lead-GND ALL	(POL-N;NEU-N;GND-N) :	3.3	µA
Lead-GND LA/AP1	(POL-N;NEU-N;GND-O) :	2.0	µA
Lead-GND RA/AP2	(POL-N;NEU-N;GND-O) :	2.1	µA
Lead-GND LL/AP3	(POL-N;NEU-N;GND-O) :	2.0	µA
Lead-GND RL/AP4	(POL-N;NEU-N;GND-O) :	2.1	µA
Lead-GND V1-V6	(POL-N;NEU-N;GND-O) :	2.0	µA
Lead-GND AP1-3	(POL-N;NEU-N;GND-O) :	3.5	µA
Lead-GND AP1-4	(POL-N;NEU-N;GND-O) :	3.6	µA
Lead-GND AP4-10	(POL-N;NEU-N;GND-O) :	3.6	µA
Lead-GND ALL	(POL-N;NEU-N;GND-O) :	3.6	µA
Lead-GND LA/AP1	(POL-N;NEU-O;GND-N) :	2.0	µA
Lead-GND RA/AP2	(POL-N;NEU-O;GND-N) :	2.0	µA
Lead-GND LL/AP3	(POL-N;NEU-O;GND-N) :	1.9	µA
Lead-GND RL/AP4	(POL-N;NEU-O;GND-N) :	2.0	µA
Lead-GND V1-V6	(POL-N;NEU-O;GND-N) :	2.0	µA
Lead-GND AP1-3	(POL-N;NEU-O;GND-N) :	3.4	µA
Lead-GND AP1-4	(POL-N;NEU-O;GND-N) :	3.5	µA
Lead-GND AP4-10	(POL-N;NEU-O;GND-N) :	3.4	µA
Lead-GND ALL	(POL-N;NEU-O;GND-N) :	3.4	µA
Lead-GND LA/AP1	(POL-R;NEU-N;GND-N) :	1.9	µA
Lead-GND RA/AP2	(POL-R;NEU-N;GND-N) :	1.9	µA
Lead-GND LL/AP3	(POL-R;NEU-N;GND-N) :	1.8	µA
Lead-GND RL/AP4	(POL-R;NEU-N;GND-N) :	1.8	µA
Lead-GND V1-V6	(POL-R;NEU-N;GND-N) :	1.8	µA
Lead-GND AP1-3	(POL-R;NEU-N;GND-N) :	3.3	µA
Lead-GND AP1-4	(POL-R;NEU-N;GND-N) :	3.4	µA
Lead-GND AP4-10	(POL-R;NEU-N;GND-N) :	3.3	µA
Lead-GND ALL	(POL-R;NEU-N;GND-N) :	3.3	µA
Lead-GND LA/AP1	(POL-R;NEU-N;GND-O) :	2.1	µA
Lead-GND RA/AP2	(POL-R;NEU-N;GND-O) :	2.2	µA
Lead-GND LL/AP3	(POL-R;NEU-N;GND-O) :	2.1	µA
Lead-GND RL/AP4	(POL-R;NEU-N;GND-O) :	2.2	µA
Lead-GND V1-V6	(POL-R;NEU-N;GND-O) :	2.1	µA
Lead-GND AP1-3	(POL-R;NEU-N;GND-O) :	3.6	µA
Lead-GND AP1-4	(POL-R;NEU-N;GND-O) :	3.6	µA
Lead-GND AP4-10	(POL-R;NEU-N;GND-O) :	3.6	µA

vPad-ES OPERATORS MANUAL

Lead-GND	ALL	(POL-R; NEU-N; GND-O) :	3.6 μ A
Lead-GND	LA/AP1	(POL-R; NEU-O; GND-N) :	2.0 μ A
Lead-GND	RA/AP2	(POL-R; NEU-O; GND-N) :	2.1 μ A
Lead-GND	LL/AP3	(POL-R; NEU-O; GND-N) :	2.0 μ A
Lead-GND	RL/AP4	(POL-R; NEU-O; GND-N) :	2.0 μ A
Lead-GND	V1-V6	(POL-R; NEU-O; GND-N) :	2.0 μ A
Lead-GND	AP1-3	(POL-R; NEU-O; GND-N) :	3.5 μ A
Lead-GND	AP1-4	(POL-R; NEU-O; GND-N) :	3.6 μ A
Lead-GND	AP4-10	(POL-R; NEU-O; GND-N) :	3.6 μ A
Lead-GND	ALL	(POL-R; NEU-O; GND-N) :	3.5 μ A
Lead-Ld	LA/AP1	(POL-N; NEU-N; GND-N) :	1.7 μ A
Lead-Ld	RA/AP2	(POL-N; NEU-N; GND-N) :	1.7 μ A
Lead-Ld	LL/AP3	(POL-N; NEU-N; GND-N) :	1.8 μ A
Lead-Ld	RL/AP4	(POL-N; NEU-N; GND-N) :	1.7 μ A
Lead-Ld	V1-V6	(POL-N; NEU-N; GND-N) :	1.8 μ A
Lead-Ld	LA/AP1	(POL-N; NEU-N; GND-O) :	2.0 μ A
Lead-Ld	RA/AP2	(POL-N; NEU-N; GND-O) :	2.1 μ A
Lead-Ld	LL/AP3	(POL-N; NEU-N; GND-O) :	2.0 μ A
Lead-Ld	RL/AP4	(POL-N; NEU-N; GND-O) :	2.0 μ A
Lead-Ld	V1-V6	(POL-N; NEU-N; GND-O) :	2.1 μ A
Lead-Ld	LA/AP1	(POL-N; NEU-O; GND-N) :	1.9 μ A
Lead-Ld	RA/AP2	(POL-N; NEU-O; GND-N) :	2.0 μ A
Lead-Ld	LL/AP3	(POL-N; NEU-O; GND-N) :	1.9 μ A
Lead-Ld	RL/AP4	(POL-N; NEU-O; GND-N) :	2.0 μ A
Lead-Ld	V1-V6	(POL-N; NEU-O; GND-N) :	1.9 μ A
Lead-Ld	LA/AP1	(POL-R; NEU-N; GND-N) :	1.8 μ A
Lead-Ld	RA/AP2	(POL-R; NEU-N; GND-N) :	1.8 μ A
Lead-Ld	LL/AP3	(POL-R; NEU-N; GND-N) :	1.9 μ A
Lead-Ld	RL/AP4	(POL-R; NEU-N; GND-N) :	1.8 μ A
Lead-Ld	V1-V6	(POL-R; NEU-N; GND-N) :	1.9 μ A
Lead-Ld	LA/AP1	(POL-R; NEU-N; GND-O) :	2.2 μ A
Lead-Ld	RA/AP2	(POL-R; NEU-N; GND-O) :	2.1 μ A
Lead-Ld	LL/AP3	(POL-R; NEU-N; GND-O) :	2.2 μ A
Lead-Ld	RL/AP4	(POL-R; NEU-N; GND-O) :	2.1 μ A
Lead-Ld	V1-V6	(POL-R; NEU-N; GND-O) :	2.2 μ A
Lead-Ld	LA/AP1	(POL-R; NEU-O; GND-N) :	2.1 μ A
Lead-Ld	RA/AP2	(POL-R; NEU-O; GND-N) :	2.1 μ A
Lead-Ld	LL/AP3	(POL-R; NEU-O; GND-N) :	2.0 μ A
Lead-Ld	RL/AP4	(POL-R; NEU-O; GND-N) :	2.1 μ A
Lead-Ld	V1-V6	(POL-R; NEU-O; GND-N) :	2.0 μ A
Iso Test	LA/AP1	(POL-N; NEU-N; GND-N) :	26.8 μ A
Iso Test	RA/AP2	(POL-N; NEU-N; GND-N) :	26.8 μ A
Iso Test	LL/AP3	(POL-N; NEU-N; GND-N) :	26.9 μ A
Iso Test	RL/AP4	(POL-N; NEU-N; GND-N) :	26.8 μ A
Iso Test	V1-V6	(POL-N; NEU-N; GND-N) :	26.8 μ A
Iso Test	AP1-3	(POL-N; NEU-N; GND-N) :	35.0 μ A
Iso Test	AP1-4	(POL-N; NEU-N; GND-N) :	35.0 μ A
Iso Test	AP4-10	(POL-N; NEU-N; GND-N) :	35.0 μ A
Iso Test	ALL	(POL-N; NEU-N; GND-N) :	35.0 μ A
Iso Test	LA/AP1	(POL-R; NEU-N; GND-N) :	28.5 μ A
Iso Test	RA/AP2	(POL-R; NEU-N; GND-N) :	28.4 μ A
Iso Test	LL/AP3	(POL-R; NEU-N; GND-N) :	28.4 μ A
Iso Test	RL/AP4	(POL-R; NEU-N; GND-N) :	28.4 μ A
Iso Test	V1-V6	(POL-R; NEU-N; GND-N) :	28.5 μ A
Iso Test	AP1-3	(POL-R; NEU-N; GND-N) :	36.5 μ A
Iso Test	AP1-4	(POL-R; NEU-N; GND-N) :	36.5 μ A
Iso Test	AP4-10	(POL-R; NEU-N; GND-N) :	36.5 μ A
Iso Test	ALL	(POL-R; NEU-N; GND-N) :	36.5 μ A

vPad-ES OPERATORS MANUAL

Test the patient monitor response with some
ECG simulations...

ECG Test: SQR 2Hz
ECG Test: TRI 2Hz
ECG Test: PUL 4sec
ECG Test: PUL 30ppm
ECG Test: PUL 60ppm
ECG Test: SQR 1KHz
ECG Test: SIN 0.5Hz
ECG Test: SIN 10Hz
ECG Test: SIN 40Hz
ECG Test: SIN 50Hz
ECG Test: SIN 60Hz
ECG Test: SIN 100Hz
ECG Test: CMRR SQR 2Hz
ECG Test: CMRR PUL 4sec
ECG Test: CMRR SIN 0.5Hz
ECG Test: CMRR SIN 50HZ
ECG Test: CMRR SIN 60HZ
ECG Test: CMRR SQR 1KHz
ECG Test: 30 BPM
ECG Test: 60 BPM
ECG Test: 120 BPM
ECG Test: 180 BPM
ECG Test: 240 BPM
ECG Test: 300 BPM
ECG Test: VFIB
ECG Test: AFIB
ECG Test: SVT
ECG Test: VTACH
ECG Test: PVC
ECG Test: ASYS
ECG monitor is OK.

Final comments are inserted at the end of the
Test Record...

1. PM tag affixed.
2. Parts inventory updated.

END OF RECORD

